



# INDUSTRIAL CATALOGUE

Since 1948 designing and  
manufacturing filtration  
systems

2024

[www.lama.es](http://www.lama.es)



Filtration



Technology



Water

# INDEX

<b>03</b>	<b>LAMA filter applications</b>
<b>04</b>	Advantages and technology
<b>07</b>	New e-commerce <b>LAMA</b>
<b>08</b>	Warranty and quality certificates
<b>09</b>	<b>1. - Microfiltration LAMA</b>
<b>10</b>	1.1 - Microfiltration PVC
<b>11</b>	1.2 - Microfiltration PRFV
<b>12</b>	<b>2. - Media filters LAMA</b>
<b>15</b>	2.1 - Low media filters
<b>16</b>	2.2 - High media filters
<b>18</b>	2.3 - Special media filters
<b>20</b>	2.4 - Horizontal media filters
<b>21</b>	<b>3. - Disc LAMA</b>
<b>23</b>	3.1 - Autosenior compact
<b>24</b>	3.2 - Autosenior compact with ringlock clamp
<b>25</b>	3.3 - Automatic disc AutoSenior 4"
<b>26</b>	3.4 - Compact modular automatic disc stationsRotativos
<b>27</b>	3.5 - Compact modular automatic disc stationsAutoMaster
<b>27</b>	3.6 - Compact modular automatic disc stations MasterMegadisc
<b>28</b>	3.7 - Manual disc Senior filters
<b>29</b>	3.8 - Metal manual disc filters
<b>30</b>	<b>4 - Screen LAMA</b>
<b>32</b>	4.1 - Electric automatic filters Automesh
<b>34</b>	4.2- Electric automatic filters Calado
<b>36</b>	4.3 - Hydraulic automatic filters Eko.Lu.
<b>38</b>	4.4 - Hydraulic automatic filters Eko
<b>39</b>	4.5 - Hydraulic automatic filters EkoSenior
<b>40</b>	4.6 - Manual screen Senior filters
<b>41</b>	4.7 -Manual metal screen filters
<b>42</b>	4.8 - Centrifuge metal screen filters
<b>43</b>	4.9 - Screen semiautomatic filters
<b>44</b>	<b>Programmer</b>
<b>45</b>	<b>Hydrocyclones</b>
<b>46</b>	<b>Valves LAMA</b>
<b>48</b>	<b>Accesoires and spare parts</b>
<b>55</b>	Sales conditions

**IMPORTANT WARNING:** the price list for the current fiscal year 2024, that is published herein, is merely informative, and is an estimation, so it could undergo changes throughout the year due to possible changes in the price of raw materials. The company is neither subject to nor obliged to maintain the prices indicated in the tariff, nor to publish any potential variation thereof. The version of the website <https://lama.es/distribuidores-lama> is the current and updated version.





## LAMA FILTER APPLICATIONS

**Service water**

**Drinking water filtration**

**Wastewater treatment**

**Process water recirculation systems**

**Process water cooling systems**

**Inlet process water**

**Industrial sewage water**

**Industrial mussel water treatment**

**Ballast water**

## Advantages, Technology and Sustainability

### RESPONSIBLE MANAGEMENT

#### - NEW SURFACE TREATMENT FOR STEEL FILTERS

After a process of change in the surface treatment that our filters are submitted, we have introduced the process called **NANOTECHNOLOGY** in one of the baths. It brings more security, ecology, flexibility and less water and energy are used.

#### - NEW NANOPLUS TECHNOLOGY TREATMENT

The new **NANOPLUS TECHNOLOGY** treatment, which is applied to our screen filters, improves their performance, durability and resistance.

#### - NO MORE ELECTRICITY:

Due to our commitment to sustainability, LAMA **will not use electrical consumption** in all the factory.

We have installed of a **solar thermal plant**. The solar station will provide all the necessary energy that Lama needs for the regular activity; which is 132 kv.



**nanoPLUS<sup>+</sup>**  
TECHNOLOGY



### QR CODES AS A COMMITMENT TO RESOURCE OPTIMISATION

Thanks to the **personalized QR code** and its data synthesis capacity, the user will be able to access the following content in a simple and agile way:

- **Main characteristics.**
- **Download product data.**
- **Download user guide.**
- **Assembly and disassembly video.**
- **Reference images of these products.**

Furthermore, we ensure that the customer is always up to date with the information they need for the proper operation of their filter, valve or programmer.

### RESTRUCTURE OUR PACKAGING OF OUR PRODUCTS

According to of sustainable management agenda, we have started to restructure our packaging of our products. Specifically, we have started this process with our **SAND filters**.

Thanks to this choice, we have reduced our use of **plastic by 93%**, which equates to **1.4kg less plastic per sand filter** shipped.



# NEW AUTOMATIC SCREEN FILTERS

## AutoMesh & EkoLU



Registered design

### NEW AUTOMATIC SCREEN FILTERS

We are launching to the market our new automatic screen filters **AutoMesh®** and **EKO LU®**.

Many product features have been improved, thanks to the processes of the company's R&D Department; **the morphology of the filters body, the accessories have been reorganised and an increased useful surface.**

The main new feature is the system's ground breaking **filtering cartridge**. The engineering depart-

The tight-fitted sections result in an **increased useful surface** when compared to other cartridges sold in the market.

ment has carefully studied the resistance of the new cartridge, with mathematical formulas used to simulate possible deformations. It has been designed with a honeycomb structure, **fully injected in polyamide**. In addition, the injection process is carried out in a single cartridge-screen phase. The cartridge is optimised for the cleaning process, using the water used during this phase.

All of this will achieve higher manufacturing speeds and shorter delivery times.

## LAMA Programmers

---

### RIO8

#### NEW PROGRAMMER RIO®

Our automatic filter stations are equipped with efficient cleaning programmers, such as the new **RIO®** device. It has 8 outputs (220v) and is very easy to use, just follow a few steps to be fully configured and ready to work. It has a control unit from which all available operations can be performed. The programmer is available in Spanish, English and French.



### mini's

The cleaning programmer **Mini's** is designed for the **automatic hydraulic screen filter** family EKO (EKO, EKOLU and EKOSENIOR).

The end-user does not have to worry about programming the duration of the backwashing so the regulation is automatic. The limit switch regulates itself automatically, depending on the flow and pressure, thanks to an inductive sensor in the hydraulic cylinder of the filters.

Furthermore, **Mini'S** can be settled using batteries as well as an electrical transformer for the stations with electricity.



# E-Commerce **Lama**

Our new e-commerce offer our customers a quick and comfortable shopping experience.

Within our strategy for the coming years, one of the key points is the optimization of the buying process. This project has meant for **LAMA** a revision of the processes, with the objective of being the leading company within the sector for professionals both for the online and offline channels.

**The new e-commerce LAMA** supposes for our clients a great number of improvements, that we would like to summarize in 4 points:

**1. Quick purchase in a single click:** we have reorganized the product families, as well as the descriptions of the articles to facilitate the search of it in a single step.

**2. 100% responsive page:** the possibility of making your purchases or management from any device, whether it is a computer, smartphone or tablet.

**3. 24/7 online management:** we have incorporated all the information so that you can consult and download your orders, invoices or delivery notes.

**4. Direct communication with the customer:** we want to inform our customers automatically about the status of their requirements or orders, so the purchase process is always updated. All this, accompanied by a close and reliable communication.

The illustration features a central tablet held by two hands, displaying the Lama e-commerce interface. The interface includes a navigation menu, a 'Mi compra' (My purchase) section with a list of items, and a 'Suscribirse a nuestra Newsletter' (Subscribe to our Newsletter) section. Surrounding the tablet are six circular callouts, each containing a different industrial product: two red metal tools, two black industrial lamps, two gauges and a red flange, and three black O-rings. A QR code is positioned in the top right corner of the illustration area.

[www.lamastore.es](http://www.lamastore.es)

# Quality Certificates and Warranty



## MANUFACTURING STANDARDS

All of our products are subject to strict quality controls during the manufacturing process, apart from completely fulfilling current regulations as well as for the elaboration of filtering equipment for agriculture use, both at an international and a European level (ISO and CEN are currently being updated and others are being fulfilled). LAMA actively takes part as a member of the working group WG5 of the technical committee TC334 of CEN).

**LAMA** has a quality insurance system certified according to the norm **ISO-9001:2015 by SGS as designing and manufacturing of filtering systems.**

Our products are in agreement with the whole of its obligations that concern us in accordance with the instruction established for the **CE** positioning.



Made in Spain







# 1. Microfiltration

**Microfiltration** is a very efficient technology for separating solids and recovering products from all types of liquids. Microfiltration retains a smaller particle size than a conventional filter; cartridges used for microfiltration have a pore size of 1-20  $\mu\text{m}$ . As the pores are so small, an additional advantage of these filters is that they retain bacteria and viruses. Despite the fact that viruses are smaller than the pores of a microfiltration membrane, retention is possible because viruses are coupled to bacteria.

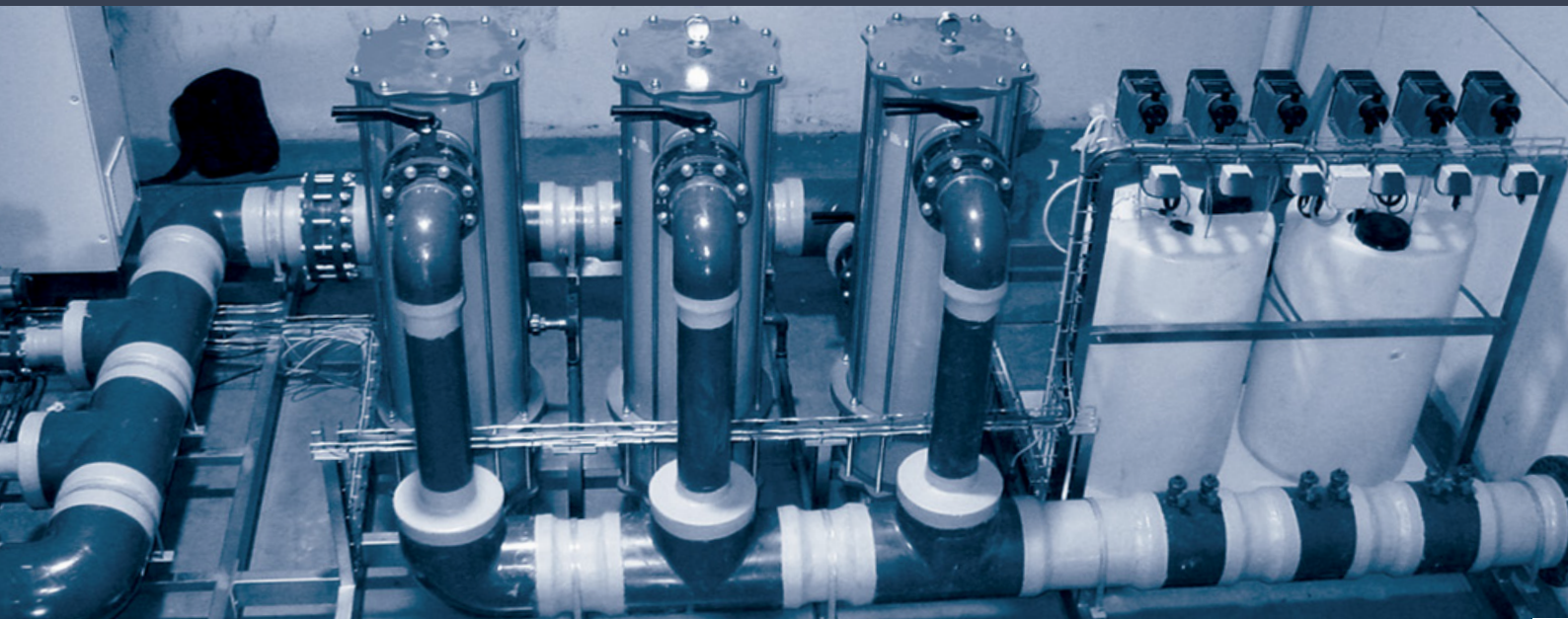

**CONSTRUCTION MATERIALS**

- **Body:** PVC
- **Joints:** synthetic rubber nitrile 60° Shore.
- **Screws:** stainless steel AISI 316L.
- **Central ring:** PVC

**FILTERING CARTRIDGES FROM 20 TO 1 µm**

(Not included in the price)

Filtration cartridges are perfectly adapted to their bases, due to the watertight joints in top part, and a compressed resort in bottom part. This fact admits different flows to the requirements

**For other microns, please ask.**

**MAXIMUM WORKING PRESSURE**

6 Kg/cm<sup>2</sup> (please ask for other pressures)

**TESTING PRESSURE**

9 Kg/cm<sup>2</sup>

**CLOSING SYSTEM**

Sainless steel nuts



Inside view of the filter.



C(mm)	Number of cartridges	A	Limit flow (m <sup>3</sup> /h)	E (mm)	F (mm)	Code
200	4	DN50*	9,6	362	-	<b>MP40-4</b>
250	7	DN65*	16,8	432	¼"	<b>MP40-7</b>
315	11	DN80**	26,4	480	¼"	<b>MP4011P</b>
400	20	DN80**	50	582	¼"	<b>MP4020P</b>
500	35	DN100**	84	712	¼"	<b>MP4035P</b>

- \*Flat connection
- \*\*Movable flange
- **Outlet** water can be rotated 90° / 180° / 270°

## 1.2 Microfiltration GFRP

## Microfiltración PRFV

### CONSTRUCTION MATERIALS

- **Body:** glass fiber reinforced polyamide (GFRP)
- **Joints:** synthetic rubber nitrile 60<sup>º</sup> Shore
- **Central ring:** PVC

### FILTERING CARTRIDGES FROM 20 TO 1 µm

(Not included in the price)

Filtration cartridges are perfectly adapted to their bases, due to the watertight joints in top part, and a compressed resort in bottom part. This fact admits different flows to the requirements

**For other microns, please ask.**

### MAXIMUM WORKING PRESSURE

8 Kg/cm<sup>2</sup> (please ask for other pressures).

### TESTING PRESSURE

12 Kg/cm<sup>2</sup>

### CLOSING SYSTEM

Adjustable lock nut

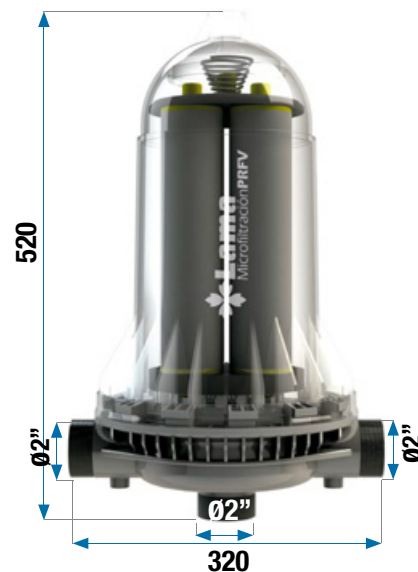

Net Weight (Kg)	Gross Weight (Kg)	Package volume (m <sup>3</sup> )	Connection (Ø)	Number of cartridges	Code
7,5	8	0,07	2"	4	FSM2

### MICROFILTRATION CARTRIDGES. Polypropylene Foam.

Description	Code
Polypropylene foam 10" (1-5-10-20-50 microns)	CPX0110
	CPX0510
	CPX1010
	CPX2010
	CPX5010

Description	Code
Polypropylene foam 40" (1-5-10-20-50 microns)	CPX0140
	CPX0540
	CPX1040
	CPX2040
	CPX5040



Polypropylene foam (Ask)



Polypropylene spool (Ask)

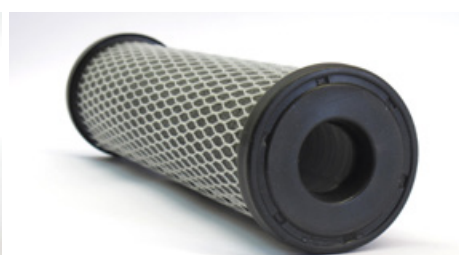

Active-carbon (Ask)

\*For any other length and cartridge number, please ask.



# 2. Media Filters

**Filtration through a layer or bed of grains** is universally known, and is possibly the most efficient of all industrial treatment systems. It is commonly known as “Sand Filtration”, although these types of systems can involve any type of bed that is optimal for particle retention functions.



## 2. Lama Media Filters

### INTRODUCTION

The filtration system through media filters is internationally known, and probably, one of the most efficient filtration systems applicable to water treatment. However these filtration systems are adaptable to any kind of particles retention, it is commonly known as "Filtration by sand filters".

The filtration through sand is produced by physical retaining the dirt into the gaps formed between the granules laid throughout the whole mantle. This is an in-depth filtration; characteristic that gives sand filtration to be system.

### APPLICATIONS

**Depending on the filter and applied filtration speed:**

- Previous filtration to Reverse Osmosis
- Drinking water
- Turbidity removal
- Fish farm water treatment
- Food and beverage industry
- Agriculture Industry
- Effluents treatment

### CLASSIFICATION

- Low Media Filter
- Special Media Filter
- High Media Filter

**According to the solid retention system:**

- Collector arm
- Nozzles

### FILTERING ELEMENT

- Siliceous sand
- Volcanic sand
- Anthracite
- Active carbon
- Glass



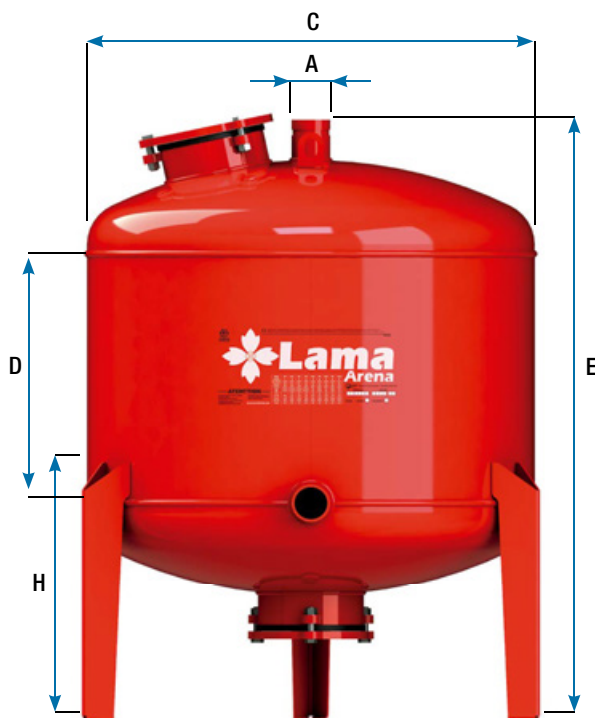

It can be manufactured under **ASME** code



**COLLECTOR ARM**

Filtration Surface (m <sup>2</sup> )	C (mm.)	A (ØVic.)	H (mm.)	D (mm.)	E (mm.)	Package volume (m <sup>3</sup> )	Sand Kg.	Code
0,096	350	1" Thread H	155	315	645	0,180	30	<b>FAV1</b>
0,196	500	1,5" Thread H	350	400	900	0,620	100	<b>FA1M</b>
0,385	700	2" Thread H	350	400	965	0,810	200	<b>FA700</b>
0,503	800	3" Thread H	450	500	1.128	0,960	300	<b>FA800</b>
0,709	950	3" Flange	450	500	1.220	1,620	500	<b>FA950</b>
1,131	1200	4" Flange	450	500	1.275	2,456	800	<b>FA1200</b>

**NOZZLES**

Filtration Surface (m <sup>2</sup> )	C (mm.)	A (ØVic.)	H (mm.)	D (mm.)	E (mm.)	Package volume (m <sup>3</sup> )	Sand Kg.	Code
0,385	700	2" Thread H	350	400	930	0,810	170	<b>FD700</b>
0,709	950	3" Flange	450	500	1.220	1,700	420	<b>FD950</b>
1,131	1200	4" Flange	450	500	1.280	2,500	700	<b>FD1200</b>

- Ask us for **VIC plastic** connection for **FA950 and FA800**.
- The **DIN flange** filters have the same price under request.
- It is recommended to add a **security filter after the sand station**.



## 2.2 High Media Filters

**LechoAlto**

### CONSTRUCTION MATERIALS

- **Body:** carbon steel A-42-B
- **Manifolds:** carbon steel or polyethylene
- **Joints:** synthetic rubber nitrile 60º Shore
- **Screws:** zinc-plated weather resistant
- **Closing cover inlet and outlet water:** 15 mm melting
- **Collector arms and nozzles:** polypropylene

### STEEL SURFACE TREATMENT

The steel elements are treated internally and externally with nanotechnology. After that, the elements are painted by electrostatic spraying powder paint, epoxy polyester (for alimentary use, please ask)

### FILTERING ELEMENT (It is not included in the price)

- Siliceous Sand
- Volcanic Sand
- Anthracite
- Active Carbon
- Pyrolusite
- Ask for another filtering element
- Glass

### SYSTEM

- Designed for low filtration rates of 5 to10 m/h
- Holes water for easy maintenance

### CLEANING

- Backwashing with clean water, it is made by pumping water backwards through the filter media, to regenerate the filtering material.
- It brings external water
- It can be combined with air

### MAXIMUM WORKING PRESSURE

- 8 Kg/cm<sup>2</sup> (standard)
- 16Kg/cm<sup>2</sup> (optional)

### TESTING PRESSURE

- 12 Kg/cm<sup>2</sup>

**\*It is recommended to add a security filter after the sand station.**

Desing and manufactured under client specifications





It can be manufactured under **ASME** code

**PRES MAX 8**  
Kg/cm<sup>2</sup>  
114 psi

Available **PRES MAX 16**  
Kg/cm<sup>2</sup>  
228 psi



**COLLECTOR ARM**

Filtration Surface (m <sup>2</sup> )	A (∅Vic.)	B (mm.)	C (mm.)	D (mm.)	E (mm.)	J (mm.)	K (mm.)	Package volume (m <sup>3</sup> )	Code
0,20	2"	1.730	500	1.400	2.215	165	165	0,3	<b>F15B</b>
0,38	2"	1.860	700	1.400	2.280	165	165	0,62	<b>F17B</b>
0,50	3"	1.873	800	1.400	2.290	165	165	0,8	<b>F18B</b>
0,71	3"	1.928	950	1.400	2.315	165	165	1,19	<b>F19B</b>
1,13	3"	1.934	1.200	1.300	2.272	165	165	1,86	<b>F12B</b>
1,54	3"	1.916	1.400	1.200	2.210	165	165	2,47	<b>F14B</b>

**NOZZLES**

Filtration Surface (m <sup>2</sup> )	A (∅Vic.)	B (mm.)	C (mm.)	D (mm.)	E (mm.)	J (mm.)	K (mm.)	Package volume (m <sup>3</sup> )	Code
0,20	2"	1.730	500	1.400	2.215	165	165	0,3	<b>F15C</b>
0,38	2"	1.860	700	1.400	2.280	165	165	0,62	<b>F17C</b>
0,50	3"	1.873	800	1.400	2.290	165	165	0,8	<b>F18C</b>
0,71	3"	1.928	950	1.400	2.315	165	165	1,19	<b>F19C</b>
1,13	3"	1.934	1.200	1.300	2.272	165	165	1,86	<b>F12C</b>
1,54	3"	1.916	1.400	1.200	2.210	165	165	2,47	<b>F14C</b>



## 2.3 Special Media Filters

LechoEspecial



Standard nozzle filters

### CONSTRUCTION MATERIALS

- **Body:** carbon steel.
- **Manifolds:** carbon steel or polyethylene.
- **Closing joints:** synthetic rubber nitrile 60° Shore.
- **Screws:** zinc-plated weather resistant.
- **Closing cover inlet and outlet water:** 15 mm melting.
- **Nozzles:** polypropylene.

### SURFACE TREATMENT

Surface treatment by high pressure sandblast, grade S.A. 21/2, according to UNE-EN ISO 8501:1988.

It is very important to create a rough surface for the best adhesion of the paint. This enables oxides and all kinds of particles to be eliminated.

#### Exterior area:

- **1<sup>st</sup> layer** of epoxi zinc phosphate primer, with a dry film thickness of 80 microns. Micronage measurement.
- **2<sup>nd</sup> layer** medium layer epoxi, with a dry film thickness is 120 microns. Micronage measurement.
- **3<sup>rd</sup> layer** of aliphatic polyurethane enamel, with a dry film thickness is 50 microns, in blue colour. Micronage measurement. For another colour/treatment, please ask us.

#### Interior area:

- **1<sup>st</sup> phase:** epoxi primer layer.
- **2<sup>nd</sup> phase:** double layer of epoxi paint without solvent **for foodstuff**, with an average dry film thickness of 350 microns. Micronage measurement.

### PERFORMANCE

- The backwashing with clean water for investment of flow, or changing the filtering material.
- The backwashing through compressed air.
- Great combination between filtración/backwashing adapted to the number of valves.
- It can be used butterfly valves, they can be pneumatic or electric.
- The control of the parametres can be done on site or remote.

**\*It is recommended to add a security filter after the sand station.**

**\*It can be manufactured in ebonite.**

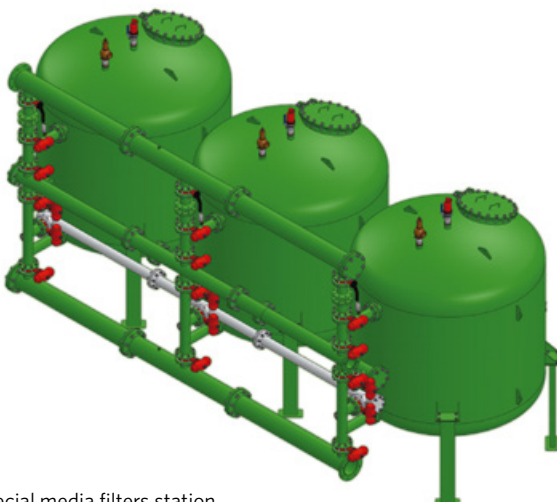

Examples of special media filters station with pneumatic butterfly valves.





Desing and manufactured under client specifications



Filtration Surface (m <sup>2</sup> )	A	B (mm.)	C (Ømm.)	D (mm.)	E (mm.)	J (mm.)	K (mm.)	Package volume (m <sup>3</sup> )	Code
1,13	3" Flange	2.736	1.200	2.000	3.176	220	460	2,66	F12CJH
1,13	3" Flange	2.236	1.200	1.500	2.676	220	460	2,1	F12CV15
1,54	3" Flange	2.820	1.400	2.000	3.217	220	460	3,7	F14CJH
1,54	3" Flange	2.320	1.400	1.500	2.717	220	460	2,93	F14CV15
2,01	3" Flange	2.907	1.600	2.000	3.259	460	460	4,75	F16CJH
2,01	3" Flange	2.407	1.600	1.500	2.759	460	460	3,78	F16CV15
2,54	3" Flange	3.006	1.800	2.000	3.307	460	460	6,32	F18CJH
2,54	3" Flange	2.506	1.800	1.500	2.807	460	460	5,05	F18CV15
3,14	4" Flange	3.087	2.000	2.000	3.347	460	460	7,95	F20CJH
3,14	4" Flange	2.587	2.000	1.500	2.847	460	460	6,41	F20CV15

## 2.4 Horizontal Media Filters

LechoEspecial

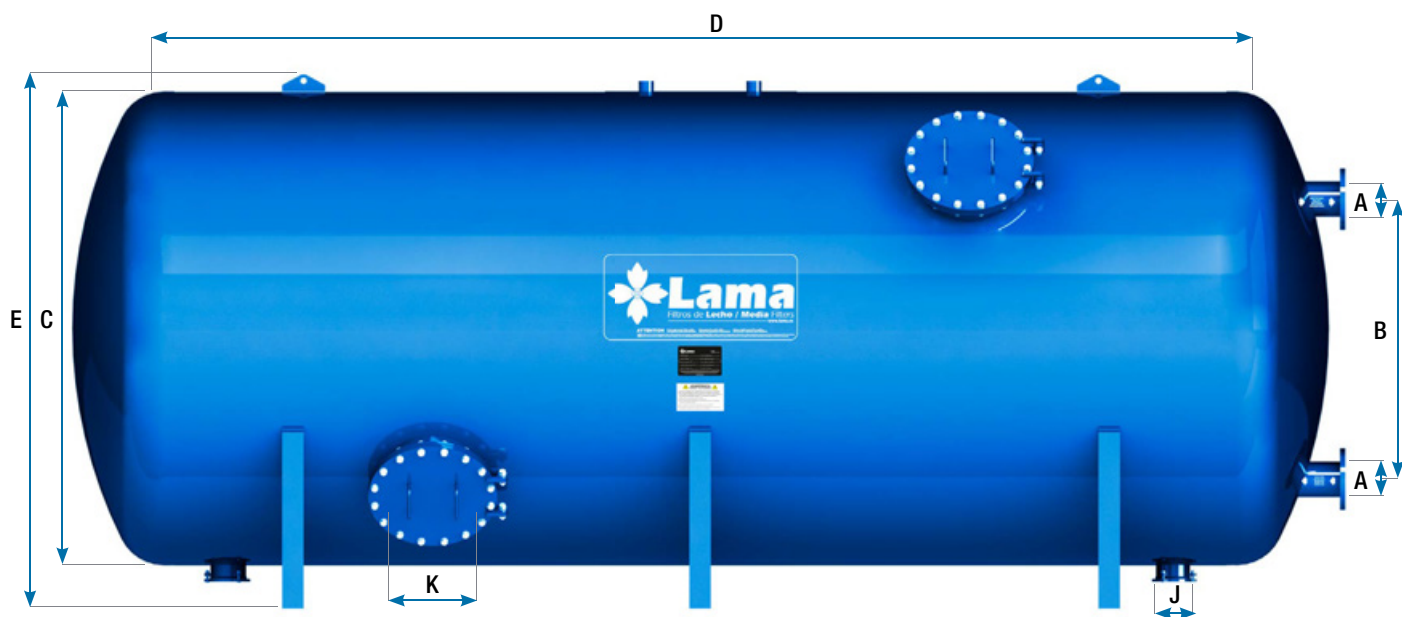

It can be  
manufactured  
under  
**ASME**  
code

Desing and manufactured  
under client specifications

Design suitable to  
container sizes

Filtration Surface (m <sup>2</sup> )	A (ØVic.)	B (mm.)	C (mm.)	D (mm.)	E (mm.)	J (mm.)	K (mm.)	Volume (m <sup>3</sup> )	Code
9,3	6" Flange	900	1.800	4.900	2.065	6"	500	13,7	<b>H18B49</b>
10,43	6" Flange	1.100	2.000	4.900	2.265	6"	500	16,9	<b>H20B49</b>
11,54	6" Flange	1.300	2.200	4.900	2.465	6"	500	20,6	<b>H22B49</b>



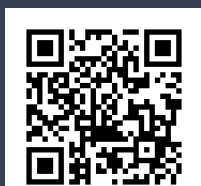

## 3. Disc Filters

**The disc performs** physical filtration by retaining solids that are not dissolved in the water in channels. Filtration takes place due to the effect of the overlapping of a set of discs, installed in a strong and secure structure. The disc channels allow filtration to take place deeply.



### 3. Disc Filters

#### CLASSIFICATION

**According to the backwashing process:**

- Self-cleaning
- Semi-automatic
- Manuals

**According to the construction material:**

- Plastic. Glass fiber reinforced polyamide
- Carbon steel

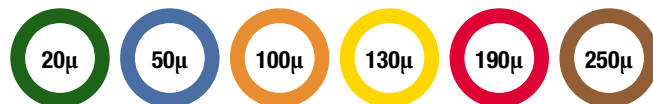

Disc standard 190µ

#### NEW AUTOSENIOR WITH TANK

Its mechanisms are perfectly synchronized to deal with the cleaning works with the guarantee that the water won't be contaminated. It allows the perfect automation of the system and a reduced head loss. Besides, it makes possible to use compressed air to guide the manoeuvres.

On the other hand, it stands out because it has just a few components, something that made easier the assembly and the taking apart works.

Furthermore, it resists to the hardest chemical and physical agents.

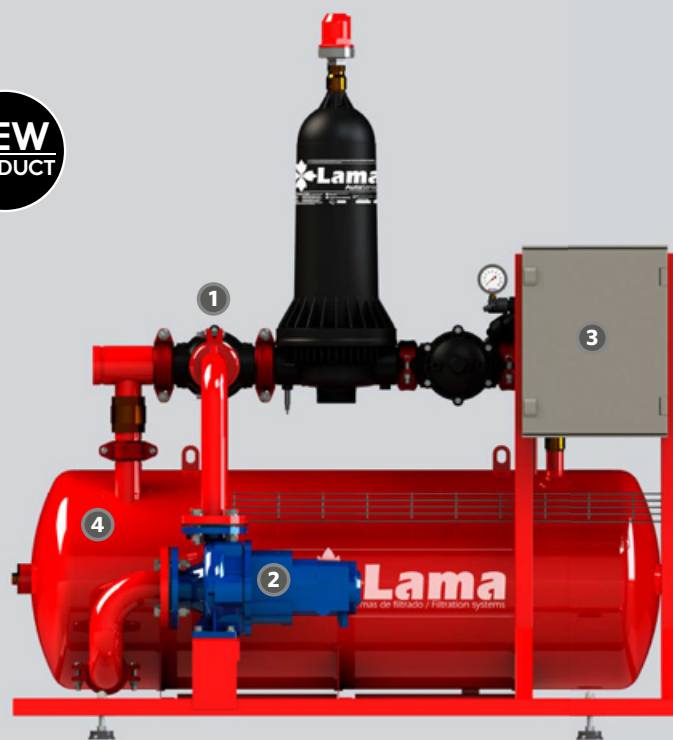

AutoSenior Model: CAS3P

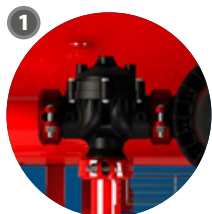

Backwashing Globo Plastic valve

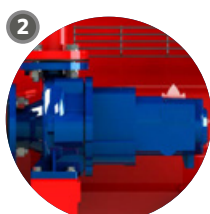

Pump equipment

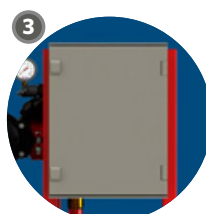

Control equipment



Clean water storage for backwash

Flow Limit 4m H.D.*	Max. recommended flow (m <sup>3</sup> /h)			Filtration Surface (cm <sup>2</sup> )	Description	Price (€)	Code
	< 50ppm	50/100ppm	100/200ppm				
70	20	12	8	1.613	1 equipped filter: tank + pump + Globo valve + solenoid + Vic coupling	Ask	CAS3P

**INFORMATION**

**Equipped:** is composed of filters + collectors + Globo Plastic valve + suction pad + manometer.

**PRES MAX 8**  
Kg/cm<sup>2</sup>  
114 psi

**2,5**  
BACKWASHING  
PRESSURE  
Kg/cm<sup>2</sup>

**ALSO FOR  
SEA WATER**



**New support legs** made in stainless steel

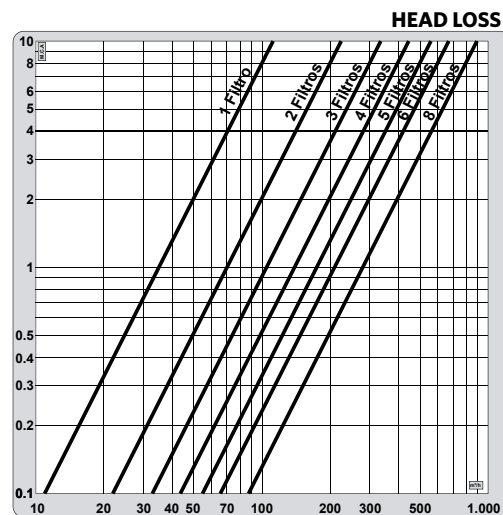

Results obtained in our factory with approved measuring instruments, using clean water as a fluid for assessment with 190 µm disc Lama.

Flow Limit 4m H.D.*	Max. recommended flow (m <sup>3</sup> /h)			Filtration Surface (cm <sup>2</sup> )	Description	Code
	< 50ppm	50/100ppm	100/200ppm			
65	20	12	8	1.613	1 unequipped	<b>FAS3TR</b>
					1 equipped Globo + Solenoid	<b>FAE3K</b>

Flow Limit 4m H.D.*	Max. recommended flow (m <sup>3</sup> /h)			Filtration Surface (cm <sup>2</sup> )	Description	Code
	< 50ppm	50/100ppm	100/200ppm			
141	40	25	16	3.226	FAS3 X 2 Ø 4"	<b>C2ASPEQS</b>
211	60	37,50	24	4.839	FAS3 X 3 Ø 4"	<b>C3ASPEQS</b>
281	80	50	32	6.452	FAS3 X 4 Ø 4"	<b>C4ASPEQS</b>
352	100	62,50	40	8.065	FAS3 X 5 Ø 6"	<b>C5ASPEQS</b>
422	120	75	48	9.678	FAS3 X 6 Ø 6"	<b>C6ASPEQS</b>
562	160	100	64	12.904	FAS3 X 8 Ø 6"	<b>C8ASPEQS</b>
703	200	125	80	16.130	10 double line	<b>10ASPEQS</b>
844	240	150	96	19.356	12 double line	<b>12ASPEQS</b>
984	280	175	112	22.582	14 double line	<b>14ASPEQS</b>
1.125	320	200	128	25.808	16 double line	<b>16ASPEQS</b>
1.265	360	225	144	29.034	18 double line	<b>18ASPEQS</b>
1.687	480	300	192	38.712	24 double line	<b>24ASPEQS</b>

Net Weight (Kg)	Net Equipped Weight (Kg)	Gross Equipped Weight (Kg)	Package Volume	Min Vol. Drainage Water (2,5 Kg/cm <sup>2</sup> )	Min. Drainage Flow (m <sup>3</sup> /h)	RAA3R - Disc spare part 190µm	KLAAS3 Compressed air cleaning kit
15	24	40	0,14 m <sup>3</sup>	45 l	10,5	Ask	Ask

- The station is supplied assembled, with the exception of the tower and cover to make shipping easier The station is delivered assembled ask us for **Vic plastic connection.**
- The drainage collector is not included. Please ask for the price.
- It is also available for **metal collectors.**
- Please ask for **Autosenior low pressure.**

**\* Consult page 44 for option with programmer and number of stations.\***



## 3.2 Automatic disc. COMPACT AUTOSENIOR

**AutoSenior**

### INFORMATION

**Station:** is composed of filters + collectors + Globo Plastic valve + suction pad + manometer



(For 1,5 Kg/cm² ask us)

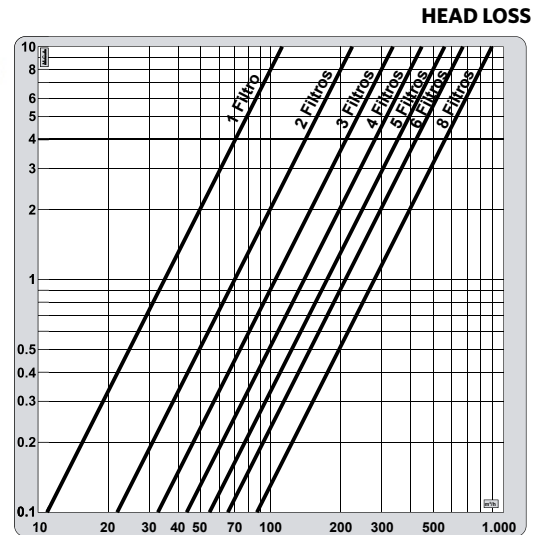

Results obtained in our factory with approved measuring instruments, using clean water as a fluid for assessment with 190 µm disc Lama.

Flow Limit 4m H.D.*	Max. recommended flow (m³/h)			Filtration Surface (cm²)	Description	Code
	< 50ppm	50/100ppm	100/200ppm			
141	40	25	16	3.226	<b>FA3K X 2 Ø 4"</b>	<b>C2A3A4S</b>
211	60	37,50	24	4.839	<b>FA3K X 3 Ø 4"</b>	<b>C3A3A4S</b>
281	80	50	32	6.452	<b>FA3K X 4 Ø 4"</b>	<b>C4A3A4S</b>
281	80	50	32	6.452	<b>FA3K X 4 Ø 6"</b>	<b>C4A3A6S</b>
352	100	62,50	40	8.065	<b>FA3K X 5 Ø 6"</b>	<b>C5A3A6S</b>
422	120	75	48	9.678	<b>FA3K X 6 Ø 6"</b>	<b>C6A3A6S</b>
562	160	100	64	12.904	<b>FA3K X 8 Ø 6"</b>	<b>C8A3A6S</b>
562	160	100	64	12.904	<b>FA3K X 8 Ø 8"</b>	<b>C8A3A8S</b>

Net Weight (Kg)	Net Equipped Weight (Kg)	Gross Equipped Weight (Kg)	Package Volume	Min Vol. Drainage Water (2,5 Kg/cm²)	Min. Drainage Flow (m³/h)	RAA3R - Disc spare part 190µm	Code
-	24	40	0,14 m³	45 l	10,5	-	<b>FAAP3ANK</b>
8	-	-	0,14 m³	45 l	10,5	-	<b>FAAP3AN</b>

- The station is supplied assembled, with the exception of the tower and cover to make shipping easier The station is delivered assembled ask us for **Vic plastic connection.**

- **FLOW LIMIT:** is what creates a head loss close to the beginning of backwash.

- The drainage collector is not included. Please ask for the price.

**\* Consult page 44 for option with programmer and number of stations.\***

**AutoSenior4"**

**3.3 Automatic discs. AUTOSENIOR 4"**

**INFORMATION**

**Equipped:** is composed of filters + collectors + Globo Plastic valve + suction pad + manometer.

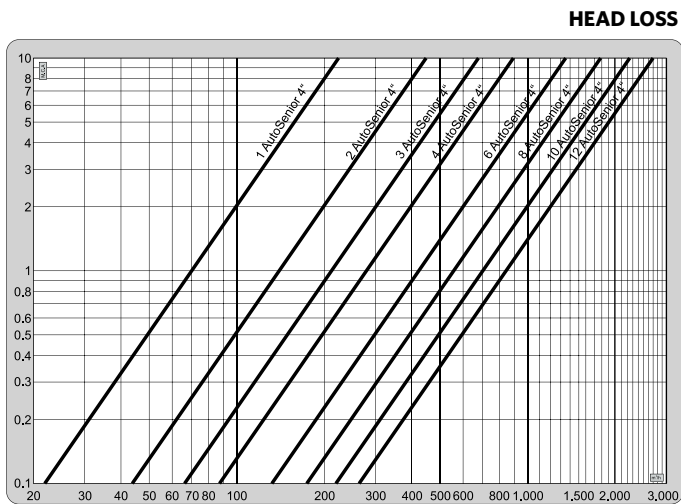

Results obtained in our factory with approved measuring instruments, using clean water as a fluid for assessment with 190 µm disc Lama.



Number of Filters	Flow Limit 4m H.D.*	Max. recommended flow (m³/h)			Filtration Surface (m²)	Min. drainage Flow (m³/h)	Collector	Code
		< 50ppm	50/100ppm	100/200ppm				
2	282	80	50	32	6.452	21	Ø6"	C2A4P3S
3	423	120	75	48	9.678	21	Ø6"	C3A4P3S
4	564	160	100	64	12.904	21	Ø8"	C4A4P3S
6	846	240	150	96	19.356	21	Ø10"	C6A4P3S
8	1.128	320	200	128	25.808	21	Ø10"	C8A4P3S
10	1.410	400	250	160	32.260	21	Ø12"	C10A4P3S
12	1.692	480	300	192	38.712	21	Ø12"	C12A4P3S

Net Weight (Kg)	Net Equipped Weight (Kg)	Gross Equipped Weight	Min Vol. Drainage Watere (2,5 Kg/cm²)	Min. Drainage Flow (m³/h)	Disc spare part 190µm-RAA3R x 2 units	KLAAS3 Compressed air cleaning kit	Code
15	32,5	0,130 m³	90 l	21	-	-	FAAP4

- Ask us for **VIC plastic** connection.
- The **drainage collector is included** in the price.

**\* Consult page 44 for option with programmer and number of stations.\***



### 3.4 Automatic discs. COMPACT MODULAR AUTOMATIC DISC STATIONS

**Rotativos**

**INFORMATION**

**Cover and disc tower** manufactured in stainless steel.  
**Security closing** in 4 steps.  
 The device is designed for **high pressures**.  
**Stabilising valve** is included in C2RL, C3RL and C4RL stations.

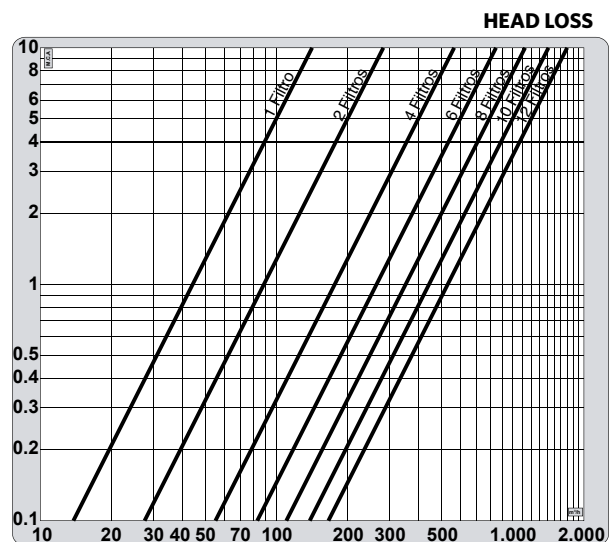

Results obtained in our factory with approved measuring instruments, using clean water as a fluid for assessment with 190 µm disc Lama.

	FRA3
<b>Net Weight (Kg)</b>	40
<b>Net equipped Weight (Kg)</b>	51
<b>Gross equipped Weight (Kg)</b>	71
<b>Package Volume (m³)</b>	0,250
<b>Min Vol. Drainage Water (2,5 Kg/cm²)</b>	60 ℓ
<b>RAR3R - Disc spare part 190µm</b>	----

available  
**3"**

2,5  
BACKWASHING  
PRESSURE  
Kg/cm²

Available  
**PRES MAX 16**  
kg/cm²  
228 psi

**PRES MAX 10**  
kg/cm²  
142 psi

Flow Limit 4m H.D.*	Max. recommended flow (m³/h)			Filtration Surface (cm²)	Min. Drainage Flow m³/h	Collector	Description	Code
	< 50ppm	50/100ppm	100/200ppm					
89	26	16	10	2.042	14	Ø3"	1 without programmer	<b>FRA3</b>
178	52	32	20	4.084	14	Ø4"	2 in line	<b>C2RLS</b>
356	104	64	40	8.168	14	Ø6"	4 in line	<b>C4RLS</b>
534	156	96	60	12.252	14	Ø8"	6 in line	<b>C6RLS</b>
712	208	128	80	16.336	14	Ø8"	8 in line	<b>C8RLS</b>
890	260	160	100	20.420	14	Ø10"	10 double line	<b>10RLS</b>
1.068	312	192	120	24.504	14	Ø10"	12 double line	<b>12RLS</b>

- Ask us for any **other composition**.

\* Consult page 44 for option with programmer and number of stations.\*

AutoMaster

3.5 Automatic discs. COMPACT MODULAR AUTOMATIC DISC STATIONS



available  
4" - 6"

2,5  
BACKWASHING  
PRESSURE  
Kg/cm<sup>2</sup>

PRES  
MAX 10  
Kg/cm<sup>2</sup>  
142 psi

nanoPLUS<sup>+</sup>  
TECHNOLOGY

Flow Limit 4m H.D.*	Max. recommended flow (m <sup>3</sup> /h)			Filtration Surface (cm <sup>2</sup> )	Min. Drainage flow (m <sup>3</sup> /h)	Description	Code
	< 50ppm	50/100ppm	100/200ppm				
211	73	44	28	4.839	31,5	1 de 4" filter unequipped	FAS4TR
211	73	44	28	4.839	31,5	1 de 4" filter equipped	FAE4
633	231	139	92	14.517	31,50	3 de 4" in line	C3AS4S
844	339	204	132	19.356	31,50	4 de 4" in line	C4AS4S
1.055	424	255	165	24.195	31,50	5 de 4" in line	C5AS4S
1.266	508	306	198	29.034	31,50	6 de 4" in line	C6AS4S
1.477	593	357	231	33.873	31,50	7 de 4" in line	C7AS4S
1.688	676	406	264	38.712	31,50	8 de 4" double line	C8AS4S
2.109	847	510	330	48.390	31,50	10 de 4" double line	10AS4S

MasterMegadisc

3.6 Automatic discs. COMPACT MODULAR AUTOMATIC DISC STATIONS



available  
4" - 6"

2,5  
BACKWASHING  
PRESSURE  
Kg/cm<sup>2</sup>

Available  
PRES  
MAX 16  
Kg/cm<sup>2</sup>  
228 psi

PRES  
MAX 10  
Kg/cm<sup>2</sup>  
142 psi

nanoPLUS<sup>+</sup>  
TECHNOLOGY

Flow Limit 4m H.D.*	Max. recommended flow (m <sup>3</sup> /h)			Filtration Surface (cm <sup>2</sup> )	Min. Drainage Flow (m <sup>3</sup> /h)	Collector	Description	Code
	< 50ppm	50/100ppm	100/200ppm					
4"	267	97	58	6.126	42	Ø4"	1 of 4" filter unequipped	FRS4
	1.068	450	270	24.504	42	Ø10"	4 of 4" filters in line	C4R4S
	1.602	675	405	36.756	42	Ø12"	6 of 4" filters in line	C6R4S
	2.136	900	540	49.008	42	Ø14"	8 of 4" filters double line	C8R4S
	3.204	1.350	810	73.512	42	Ø18"	12 of 4" filters double line	12R4S
6"	534	225	135	12.252	84	Ø6"	1 of 6" filter equipped	FRA6
	6.408	2.700	1.620	147.024	84	Ø24"	12 of 6" filters double line	12R6S
	9.024	3.600	2.160	196.032	84	Ø24"	16 of 6" filters double line	16R6S
	12.816	5.400	3.240	294.048	84	Ø30"	24 of 6" filters double line	24R6S

\* Consult page 44 for option with programmer and number of stations.\*





2" Senior thread

3" Senior connection

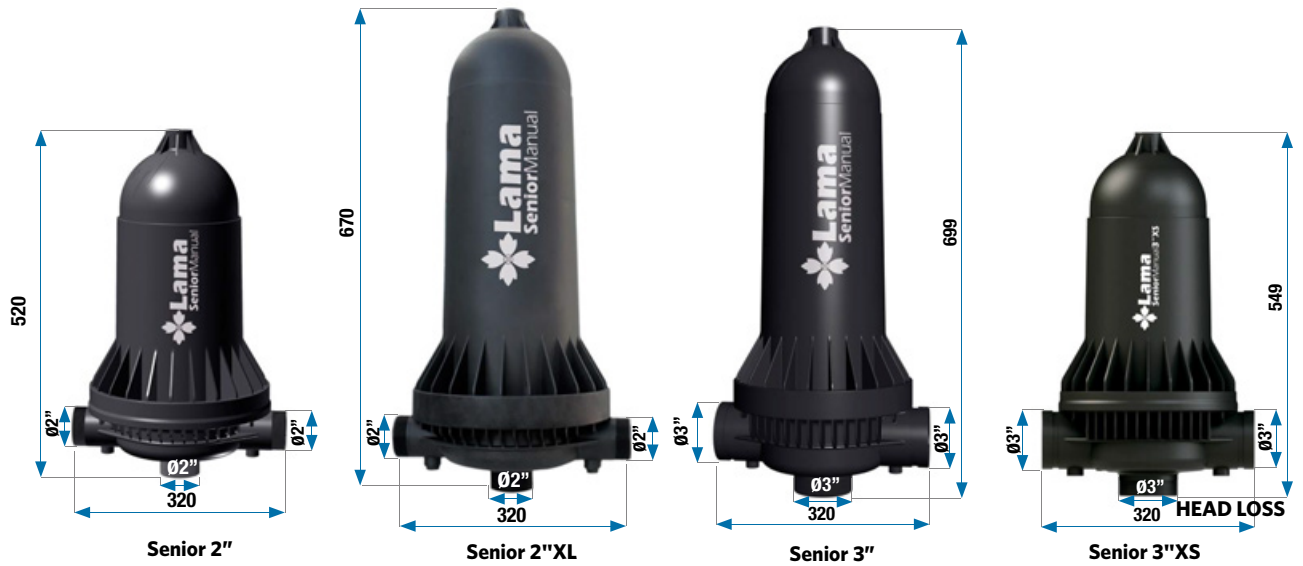

FDS3AB

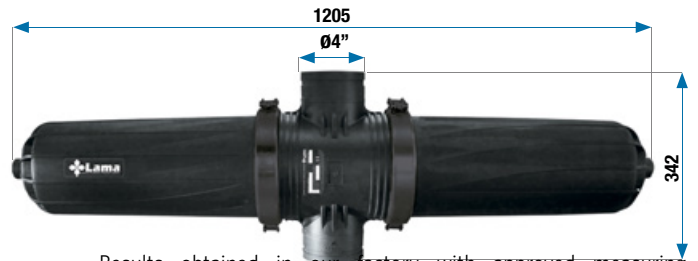

Senior 4 Results obtained in our factory with approved measuring instruments, using clean water as a fluid for assessment with 190 µm disc Lama.

Filtration Surface (cm <sup>2</sup> )	Net Weight (Kg)	Gross Weight (Kg)	Package volume (m <sup>3</sup> )	Limit Flow (m <sup>3</sup> /h)	Description	Code
1.240	5,5	6	0,04	22	Senior 2" filter · Discs · Thread B.S.P.	FDS2
1.085	5,5	6	0,04	22	Senior 2" filter · Discs centrifuge · Thread B.S.P.	FDC2
1.795	7,5	8	0,07	45	Senior 2"XL filter · Discs · Thread B.S.P. / N.P.T. 2"	FDS2XL
1.240	6,5	7	0,04	22	Senior 3"XS filter · Discs · Vic	FDS3XS
1.795	7,5	8	0,07	50	Senior 3" filter · Discs · Vic	FVD3
1.795	7,5	8	0,07	50	Senior 3" filter · Discs · Thread B.S.P.	FDS3
1.640	7,5	8	0,07	43	Senior 3" filter · Discs centrifuge · Vic	FVA3
1.640	7,5	8	0,07	43	Senior 3" filter · Discs centrifuge · Thread B.S.P.	FDC3
3.590	13,4	16,6	0,11	100	Filter Senior 4" · Discs	FVD4



### 3.8 Manuals Discs. METAL DISC FILTERS

**Metálicos**

**MATERIALS**

- Body:** A42B carbon steel
- Closing joints:** nitrile synthetic rubber 60 ° Shore
- Screws:** zinc plated weather resistant
- Crosshead:** stainless steel AISI 316L
- Connection flange:** DIN 2576 for irrigation

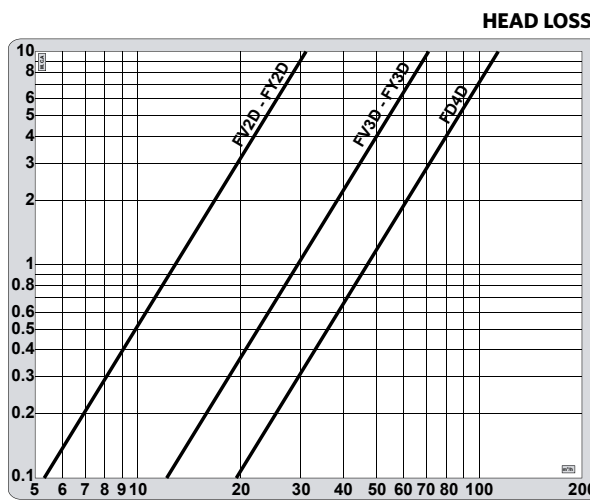
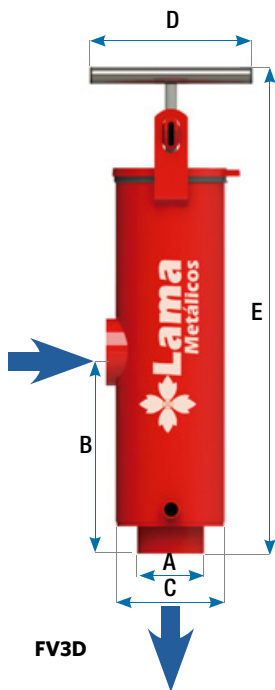
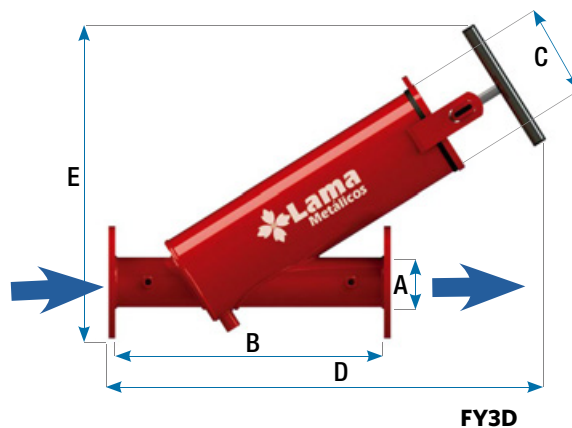
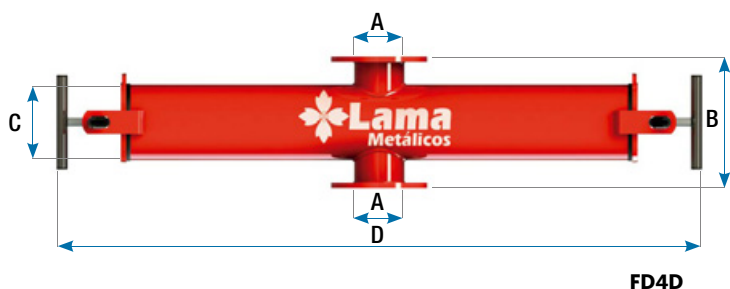

Results obtained in our factory with approved measuring instruments, using clean water as a fluid for assessment with 190 µm disc Lama.

A	B (mm)	C (mm)	D (mm)	E (mm)	Net Weight (Kg)	Gross Weight (Kg)	Package volume (m <sup>3</sup> )	Limit Flow (m <sup>3</sup> /h)	Description	Code
2" Thread H	319	165	230	540	12,5	13	0,032	22	2" vertical filter	<b>FV2D</b>
3" Thread H	275	165	230	666	15,5	16	0,070	50	3" vertical filter	<b>FV3D</b>
2" Thread M	450	165	605	520	13,5	17,5	0,070	22	2" Y filter	<b>FY2D</b>
3" Flange	500	165	750	520	21,5	22	0,089	50	3" Y filter	<b>FY3D</b>
4" Flange	290	165	1480	290	38	60	0,157	80	4" double body filter	<b>FD4D</b>
High security cartridge of parallel discs (For filters FV2D and FY2D)										<b>CA2R</b>
High security cartridge of parallel discs (For filters FV3D, FY3D and FD4D)										<b>CA3R</b>



## 3. Screen Filters

**Physical filtration occurs in screen filters** due to the retention of solids in suspension in water between the holes of the sieve. The screen behaves like a sieve that allows dirt with a smaller particle size than its holes to pass through, and retains grains larger than the holes.



# 4. Screen Lama.

## CLASSIFICATION

### According to the backwashing process :

- Electric automatic filters
- Hydraulic automatic filters
- Half-automatic
- Manual

### According to the construction material:

- Plastic. Glass fiber reinforced polyamide
- Carbon steel painted in polyester epoxy

- Standard screen for automatic filters **0,190 mm.**
- Standard screen for manual filters **0,130 mm.**

## FULL INJECTED NEW CARTRIDGE

**NEW PRODUCT**

- Great performance
- Registered design.
- More resistant
- It is available for **0,190 mm black colour for automatic standard screen** and **0,130 mm red colour for manual standard screen.**



## SCREEN SIZE

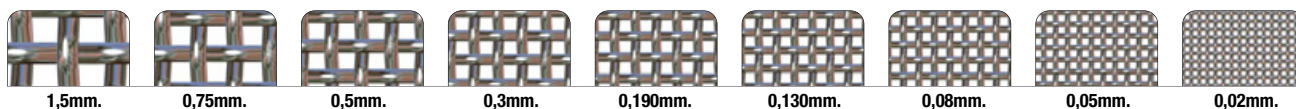

## ELECTRIC AUTOMATIC FILTER

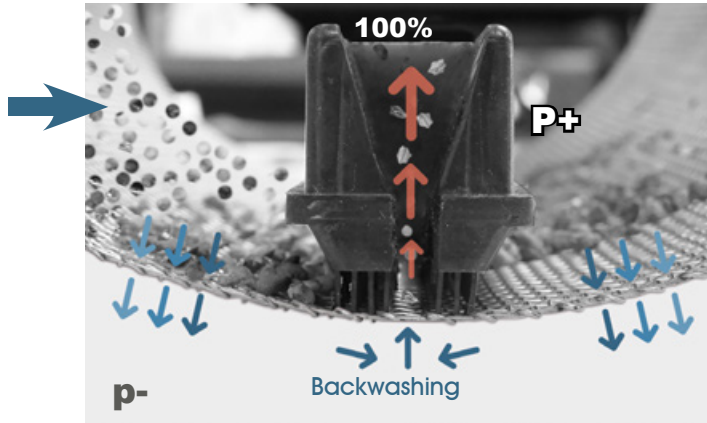
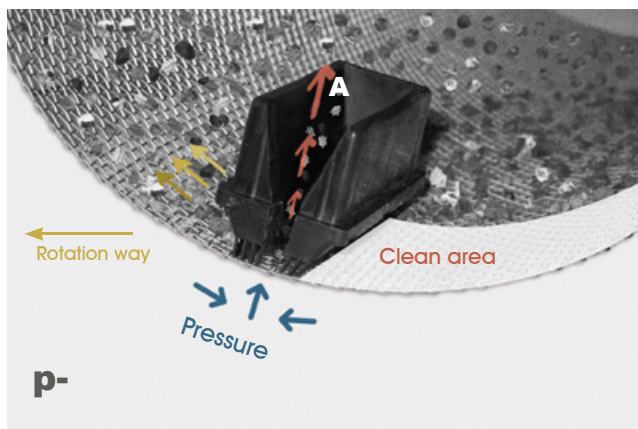

## HYDRAULIC AUTOMATIC FILTER

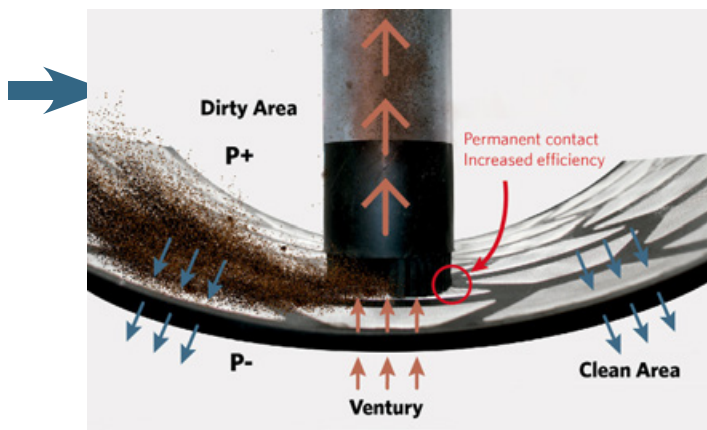
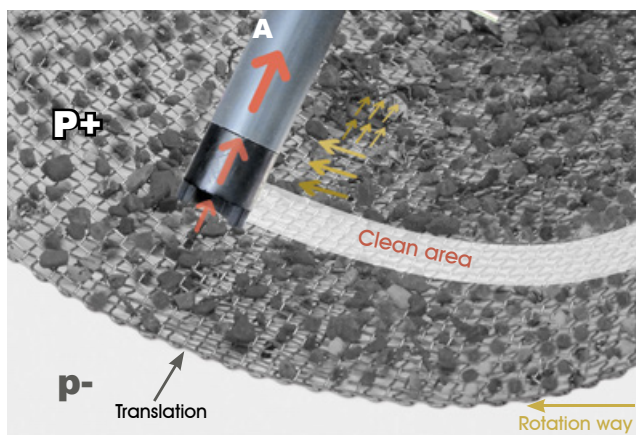

## 4.1 Automatic Screen. ELECTRIC SELF-CLEANING FILTER

### INFORMATION

The basic filters are composed of the its cartridge, the inhalation mechanism with the rubber nozzles, the electric motor and the drainage valve.

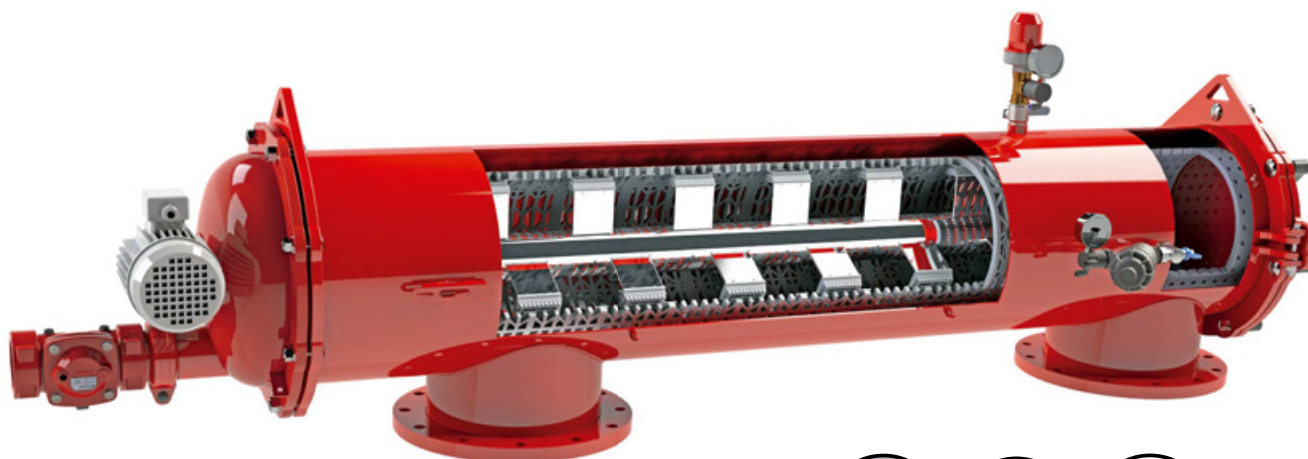

**2,5**  
BACKWASHING  
PRESSURE  
Kg/cm<sup>2</sup>

Available  
**PRES MAX 16**  
kg/cm<sup>2</sup>  
228 psi

**PRES MAX 10**  
kg/cm<sup>2</sup>  
142 psi

**nanoplus<sup>+</sup>**  
TECHNOLOGY

A	B (mm)	C (mm)	D (mm)	E (mm)	F (Ø)	G* (mm)	H (mm)	Net Weight (Kg)	Package Dimension (mm)	Package Weight (Kg)	Package volume (m <sup>3</sup> )	Code
4" Flange	450	406	1590	760	3" Vic	1270	1440	190	1900x700x850	210	1,024	<b>AM4S</b>
4" Flange	800	406	1995	741	3" Vic	1270	1835	195	1900x700x850	214	1,024	<b>AM6B4S</b>
6" Flange	800	406	2010	760	3" Vic	1270	1840	195	1900x700x850	214	1,024	<b>AM6S</b>
8" Flange	1100	406	2145	760	3" Vic	1405	1975	210	2050x700x850	250	1,105	<b>AM8S</b>
10" Flange	1100	406	2415	760	3" Vic	1675	2240	235	2320x700x850	275	1,250	<b>AM10S</b>
12" Flange	1370	406	2550	760	3" Vic	1810	2380	276	2540x700x870	302	1,323	<b>AM12S</b>
14" Flange	1.370	600	2.415	795	3" Vic	1.400	2380	525	2500x820x850	570	1,92	<b>A14ETXLS</b>

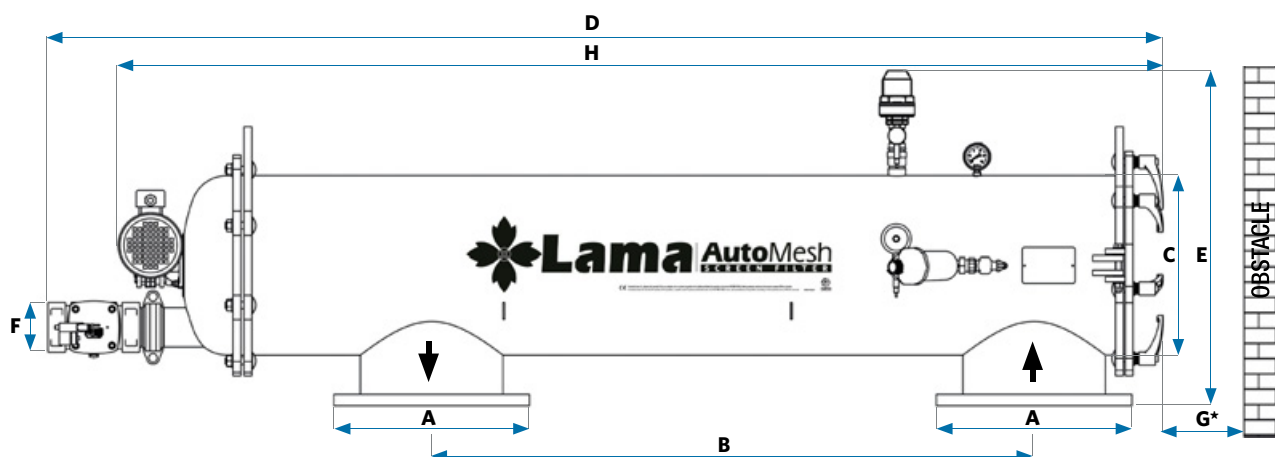

- \*Security area for the cartridge removal.
- Please ask for low pressure cleaning options.





**HEAD LOSS**

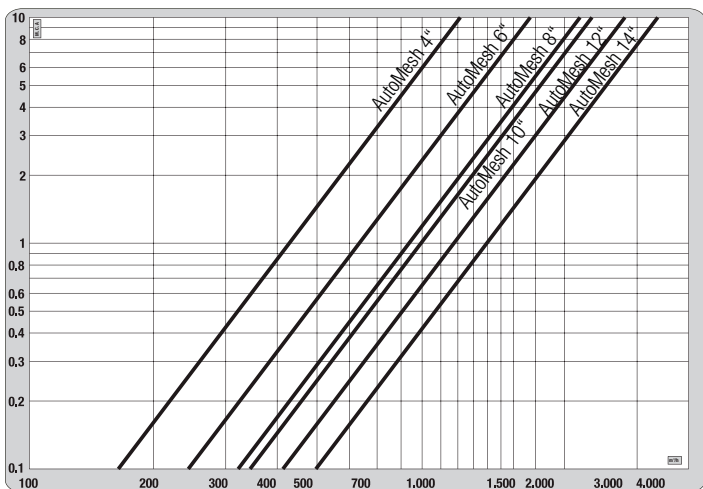

Results obtained in our factory with approved measuring instruments, using clean water as a liquid for assessment and Lama screen of 190 µm.



Flow Limit 3m H.D.	Connection	Max. recommended flow (m³/h)		Screen Surface (cm²)	Filtration Surface (cm²)	Backwashing flow (m³/h)	Backwashing Water Quantity (l)	Backwashing time (minimum)	Number of cartridges sections	Code
		< 50ppm	50/100ppm							
700	4" Flange	230	139	5.980	8.058	75	105	5"	5	<b>AM4S</b>
700	4" Flange	350	211	9.568	12.893	120	167	5"	8	<b>AM6B4S</b>
1050	6" Flange	350	211	9.568	12.893	120	167	5"	8	<b>AM6S</b>
1400	8" Flange	470	284	10.764	14.089	135	188	5"	9	<b>AM8S</b>
1480	10" Flange	490	296	13.156	16.481	165	229	5"	11	<b>AM10S</b>
1800	12" Flange	600	363	14.352	17.677	180	250	5"	12	<b>AM12S</b>
2.760	14" Flange	938	567	18.313	29.030	210	292	5"	-	<b>A14ETXLS</b>
								Rubber nozzle	<b>New</b>	<b>BAAG</b>
								Electric motor with control box 220V		<b>MOEB050</b>

<b>Cartridge section</b>	Ø outside 310 mm	Height 142 mm	0,190 mm screen	<b>T28P135</b>
<b>Cartridge section</b>	Ø outside 310 mm	Height 142 mm	0,130 mm screen	<b>T28P13R</b>

**Kit RIO 8 programmer** **Including:** Programmer, pressure sensors, solenoid and microtube. **Code: RIO8AMS**

- During the cleaning step it is not included the opening and closing valve duration.
- Ask us in case of a stabilizing valve is needed.

\* Consult page 44 for more number of stations of the RIO programmer\*



## 4.2 Automatic screen. ELECTRIC SELF-CLEANING FILTER

**Calado**

### INFORMATION

**Equipment:** filter + electric motor + drainage valve + pressure sensors + manometre

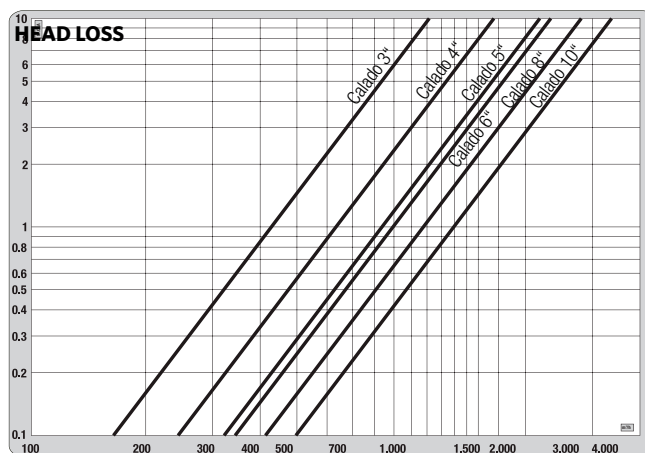
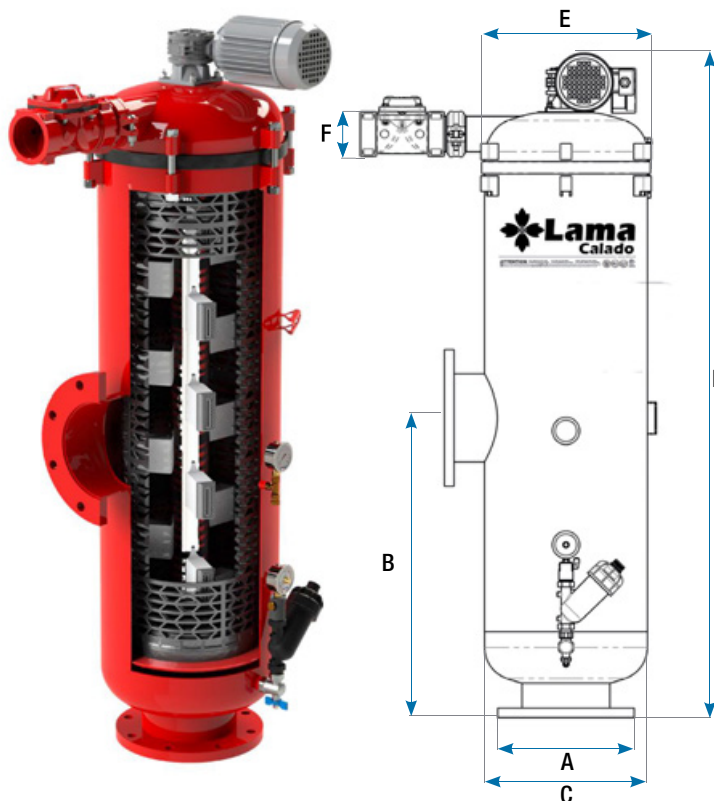

Results obtained in our factory with approved measuring instruments, using clean water as a liquid for assessment and Lama screen of 190 µm.



**nanoPLUS<sup>+</sup>**  
TECHNOLOGY

A	B (mm)	C (mm)	D (mm)	E (mm)	F	Net Weight (Kg)	Gross Weight (Kg)	Package volume (m <sup>3</sup> )	Model
3" Thread H	316	406	880	660	2" Thread H	113,5	159,5	0,53	<b>Calado 3"</b>
4" Flange	486	406	1.131	713	2" Thread H	119	169	0,58	<b>Calado 4"</b>
5" Flange	600	406	1.100	664	2" Thread H	125	175	0,77	<b>Calado 5"</b>
6" Flange	585	406	1.292	729	2" Thread H	152	229,5	0,91	<b>Calado 6"</b>
8" Flange	750	406	1.647	815	3" Thread H	199	280	1,18	<b>Calado 8"</b>
10" Flange	750	406	1.700	664	3" Vic	215	300	1,3	<b>Calado 10"</b>

Flow Limit 3m H.D.	Max. recommended flow (m <sup>3</sup> /h)		Filtration Surface (cm <sup>2</sup> )	Backwashing Pression (Kg/cm <sup>2</sup> )	Backwashing flow (m <sup>3</sup> /h)	Wash Water Quantity (l)	Backwashing time (minimum)	Code
	< 50ppm	50 / 100ppm						
374	127	77	2.533	1	22	25	5"	<b>A3CMSVS</b>
670	227	137	4.180	1	39	38	5"	<b>A4CMSVS</b>
768	261	158	4.500	1	45,5	43	5"	<b>A5CMSVS</b>
1.010	343	207	6.035	1	58,5	76	5"	<b>A6CMSVS</b>
1.321	449	271	9.283	1	83,5	88	5"	<b>A8CMS</b>
1.408	479	289	9.990	1	90	113,75	5"	<b>A10CMS</b>



\* Consult page 44 for option with programmer and number of stations.\*

### 4.3 Automatic Screen. HYDRAULIC SELF-CLEANING FILTER EKOLU.

#### INFORMATION

The filters are composed of its cartridge, the inhalation mechanism with the **new plastic nozzles** and the drainage valve.



With inductive sensor



#### HEAD LOSS

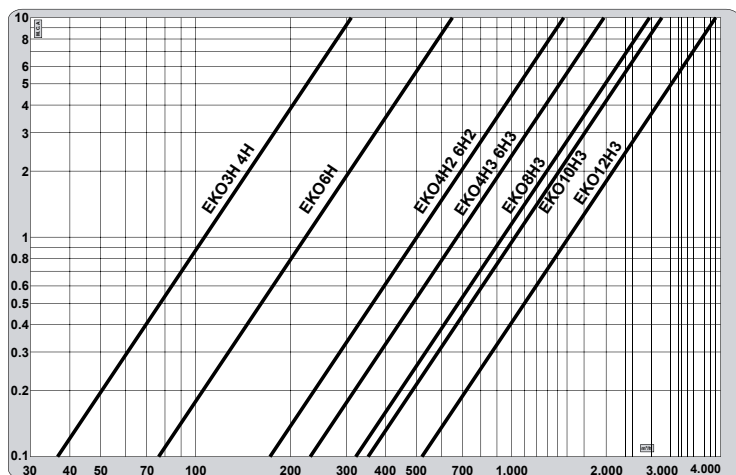

Results obtained in our factory with approved measuring instruments, using clean water as a liquid for assessment and Lama screen of 190 µm.



**nanoplus+**  
TECHNOLOGY

Flow Limit 3m H.D.	Max. recommended flow (m³/h)		Filtration Surface (cm²)	Backwashing Pression (Kg/m³)	Backwashing flow (m³/h)	Backwashing Water Quantity (l)	Backwashing time (minimum)	Number of cartridges sections	Code
	< 50ppm	50/100ppm							
180	70	37	1593	3378	6,2	34,4	20"	2 x T14P176	EKO3HS
180	70	37	1593	3378	6,2	34,4	20"	2 x T14P176	EKO4HS
720	280	150	6370	8155	15,5	215	50"	8 x T14P176	EKO4H2S
1050	350	211	9568	12893	12,4	172	50"	8 x T28P135	EKO4H3S
370	144	77	3185	4970	12,4	68,8	20"	4 x T14P176	EKO6HS
720	280	150	6370	8155	15,5	215	50"	8 x T14P176	EKO6H2S
1050	350	211	9568	12893	12,4	172	50"	8 x T28P135	EKO6H3S
1400	470	284	10764	14089	15,5	215	50"	9 x T28P135	EKO8H3S
1480	490	296	13156	16481	18,6	258	50"	11 x T28P135	EKO10H3S
1800	600	363	14352	17677	18,6	258	50"	12 x T28P135	EKO12H3S

<b>Cartridge section</b>	Ø outside 310 mm	Height 142 mm	0,190 mm screen	<b>T28P135</b>
<b>Cartridge section</b>	Ø outside 160 mm	Height 176 mm	0,190 mm screen	<b>T14P176</b>
<b>Cartridge section</b>	Ø outside 310 mm	Height 142 mm	0,130 mm screen	<b>T28P13R</b>
<b>Cartridge section</b>	Ø outside 160 mm	Height 176 mm	0,130 mm screen	<b>T14P17R</b>

**Kit programador Mini's** Including: solenoid, differential pressure regulator and microtube

Código: FLMSPRES

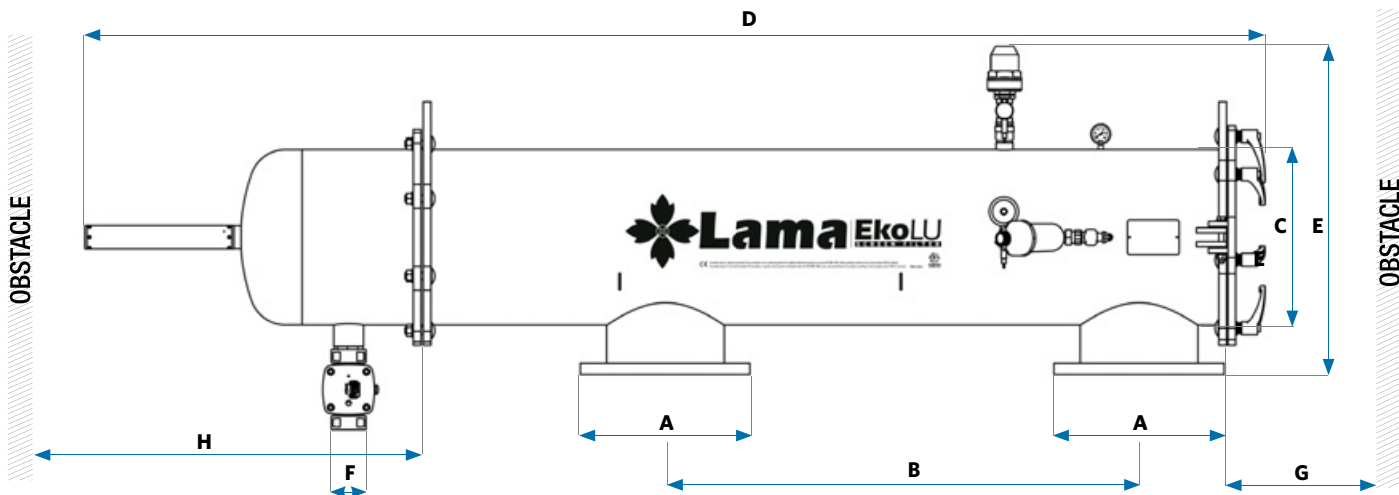

A (Ø)	B (mm)	C (mm)	D (mm)	E (mm)	F (Ø)	G* (mm)	H (mm)	Net Weight (Kg)	Package Dimension (mm)	Package Weight (Kg)	Package volume (m <sup>3</sup> )	Code
3" Flange	450	220	1.240	370	1" H	355	365	50	1200x600x310	55	0,223	<b>EKO3HS</b>
4" Flange	450	220	1240	370	1" H	355	365	50	1200x600x310	55	0,223	<b>EKO4HS</b>
4" Flange	900	220	2600	370	2" H	355	1421	75	2310x700x850	115	1,37	<b>EKO4H2S</b>
4" Flange	800	406	2280	760	2" H	1270	80	185	2070x700x850	226	1,23	<b>EKO4H3S</b>
6" Flange	750	220	1600	370	1" ½ H	355	717	68	1420x700x850	110	0,26	<b>EKO6HS</b>
6" Flange	900	220	2600	370	2" H	355	1421	75	2310x700x850	120	1,37	<b>EKO6H2S</b>
6" Flange	800	406	2280	760	2" H	1270	80	190	2050x700x850	226	1,21	<b>EKO6H3S</b>
8" Flange	1100	406	2415	760	2" H	1405	80	205	2200x700x850	240	1,30	<b>EKO8H3S</b>
10" Flange	1100	406	2685	760	2" H	1675	80	230	2400x700x850	270	1,42	<b>EKO10H3S</b>
12" Flange	1370	406	2820	760	2" H	1810	80	245	2600x700x850	280	1,54	<b>EKO12H3S</b>



- Please ask for low pressure cleaning options.

- **Mini's programmer** wash duration with **only one filter is automatic**. The programmer is not modifiable by the end user, it can be used with batteries, 220V or 12V power.

\* Consult page 44 for other option with RIO programmer and number of stations.\*

With inductive sensor

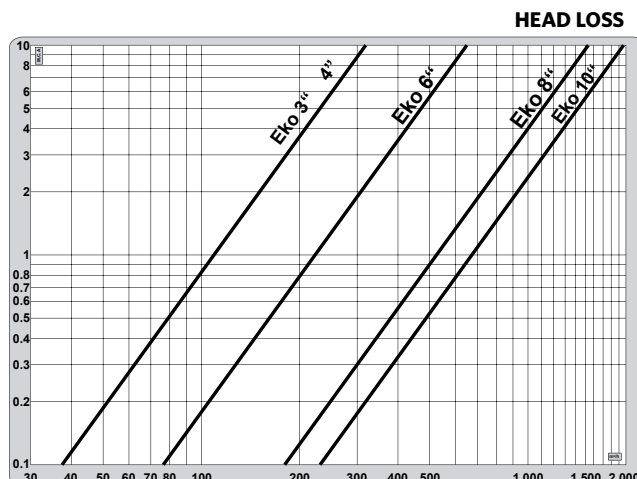
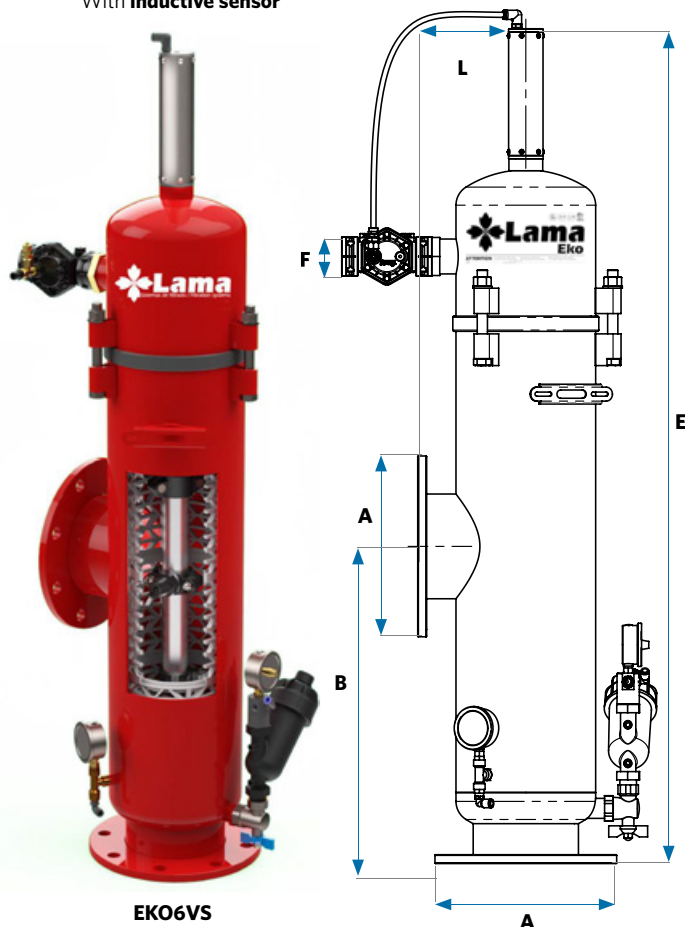

Results obtained in our factory with approved measuring instruments, using clean water as a liquid for assessment and Lama screen of 190 µm.

2,5 BACKWASHING PRESSURE Kg/cm<sup>2</sup> Available PRES MAX 16 Kg/cm<sup>2</sup> 228 psi PRES MAX 10 Kg/cm<sup>2</sup> 142 psi nanoPLUS+ TECHNOLOGY

A (Ø)	B (mm)	E (mm)	F (Ø)	L (mm)	Net Weight (Kg)	Package Dimension (mm)	Package Weight (Kg)	Package volume (m <sup>3</sup> )	Code
3" Flange	300	975	1" H	170	32	860x700x460	41	0,276	EKO3VS
4" Flange	300	975	1" H	170	33	860x700x460	42	0,276	EKO4VS
4" Flange	300	1176	1" ½ H	170	44	1260x800x550	64	0,276	EKO4VLS
6" Flange	500	1320	1" ½ H	170	56	1260x800x550	76	0,554	EKO6VS
8" Flange	585	1450	2" H	303	110	1390x700x850	130	0,827	EKO8VS
10" Flange	750	1854	2" H	303	129	1800x700x850	159	1,071	EKO10VS

Flow Limit 3m H.D.	Max. recommended flow (m <sup>3</sup> /h)		Filtration Surface (cm <sup>2</sup> )	Backwashing flow (m <sup>3</sup> /h)	Backwashing Water Quantity (l)	Backwashing time (minimum)	Prices (€)		Code
	< 50ppm	50/100ppm					Nº of cartridges		
180	70	37	1593	6,2	34,4	20"	2 x T14P176	EKO3VS	
180	70	37	1593	6,2	34,4	20"	2 x T14P176	EKO4VS	
180	107	57	2389	12,4	69	20"	3 x T14P176	EKO4VLS	
370	144	77	3185	12,4	69	20"	4 x T14P176	EKO6VS	
725	280	150	5980	14,4	80	20"	5 x T28P135	EKO8VS	
1120	432	232	9568	20	111	20"	8 x T28P135	EKO10VS	

Cartridge section	Ø outside 310 mm	Height 142 mm	0,190 mm screen	T28P135
Cartridge section	Ø outside 160 mm	Height 176 mm	0,190 mm screen	T14P176
Cartridge section	Ø outside 310 mm	Height 142 mm	0,130 mm screen	T28P13R
Cartridge section	Ø outside 160 mm	Height 176 mm	0,130 mm screen	T14P17R

Kit programador Mini's Including: solenoid, differential pressure regulator and microtube Code: FLMSPRES

- Mini's programmer wash duration with **only one filter is automatic**. The programmer is not modifiable by the end user, it can be used with batteries, 220V or 12V power.

\* Consult page 44 for other option with RIO programmer and number of stations.\*

# 4.5 Automatic Screen. HYDRAULIC SELF-CLEANING FILTER EKOSENIOR

EkoSenior

With **inductive sensor**

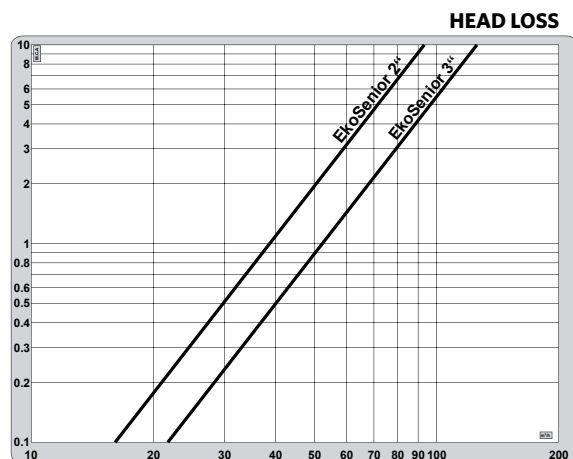
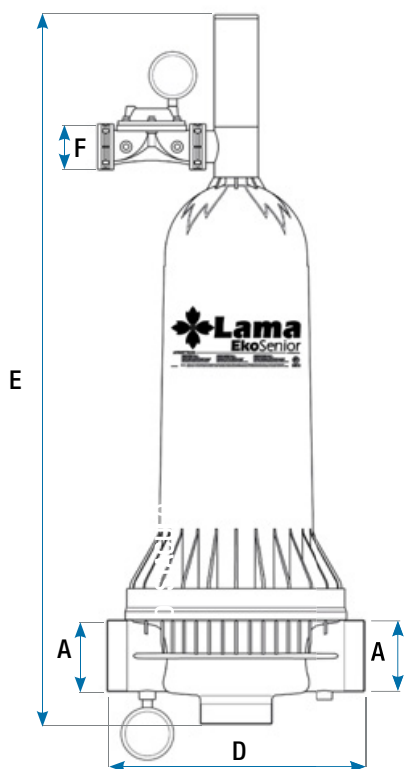

Results obtained in our factory with approved measuring instruments, using clean water as a liquid for assessment and Lama screen of 190 µm.

A (∅)	D (mm)	E (mm)	F (∅)	Net Weight (Kg)	Package Dimension (mm)	Package Weight (Kg)	Package volume (m³)	Code
2" M	320	707	1" H	8	860 x 600 x 350	10	0,180	<b>EKOSE2S</b>
3" M	320	886	1" H	11	860 x 600 x 350	13	0,180	<b>EKOSE3S</b>

Flow Limit 3m H.D.	Max. recommended flow (m³/h)		Filtration Surface (cm²)	Backwashing flow (m³/h)	Backwashing time (minimum)	Code
	< 50ppm	50/100ppm				
59	20	12	591	4	20"	<b>EKOSE2S</b>
80	40	24	1.040	6	20"	<b>EKOSE3S</b>
<b>CEKS220</b>	2" filtering cartridge 190 µm		---	<b>CEKS320</b>	3" filtering cartridge 190 µm	

**Kit programador Mini's** Including: solenoid, differential pressure regulator and microtube **Code: FLMSPRES**

// - **Mini's programme** wash duration with **only one filter is automatic**. The programmer is not modifiable by the end user, it can be used with batteries, 220V or 12V power.

\* **Consult page 44 for other option with RIO programmer and number of stations.\***

- Please ask for any other filtering screen size.

### 4.6 Manual Screen Filters. 2", 2"XL, 3"XS AND 3" SENIOR FILTER



2" Senior thread



3" Senior connection

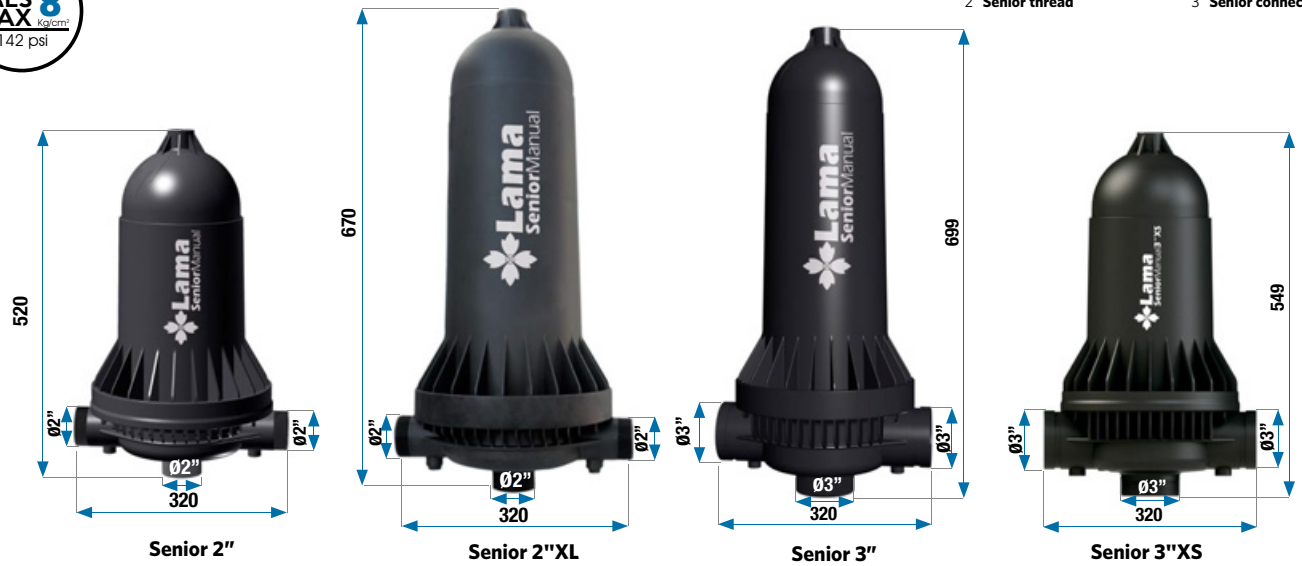

FMS3AB

HEAD LOSS

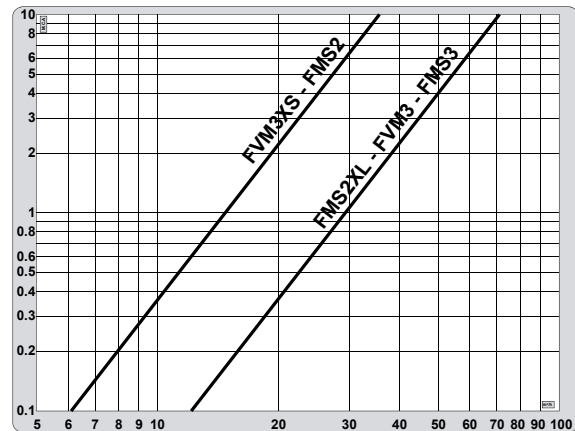

Results obtained in our factory with approved measuring instruments, using clean water as a liquid for assessment and Lama screen of 130 µm.

Filtration Surface (cm²)	Net Weight (Kg)	Gross Weight (Kg)	Package volume (m³)	Limit Flow (m³/h)	Description	Code
1.240	5,5	6	0,04	25	Senior 2" · Screen · Thread B.S.P.	FMS2
1.085	5,5	6	0,04	25	Senior 2" · Screen centrifuge · Thread B.S.P.	FCS2
1.795	7,5	8	0,07	45	Senior 2" XL · Screen · Thread B.S.P. / N.P.T.	FMS2XL
1.240	6,5	7	0,04	25	Senior 3"XS · Screen · Vic	FMS3XS
1.550	7	8	0,07	50	Senior 3" · Screen · Vic	FMS3AB
1.550	7	8	0,07	50	Senior 3" · Screen · Vic	FVM3
1.550	7	8	0,07	50	Senior 3" · Screen · Thread B.S.P.	FMS3
1.485	7	8	0,07	33	Senior 3" · Screen centrifuge · Vic	FVC3
1.485	7	8	0,07	33	Senior 3" · Screen centrifuge · Thread B.S.P.	FCS3



## 4.7 Manual Screen Filters. METAL SCREEN FILTERS

**Metálicos**

### FILTERING ELEMENT

Thermo soldered stainless steel mesh located in a cylindrical structure of drilled PVC. The standard mesh size is 0,130 mm, but it is available in other sizes (from 0,01 to 3 mm) Please ask for prices.

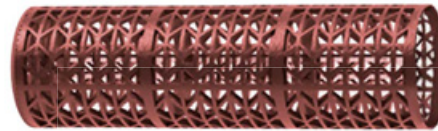

FM3000

FM4000

### HEAD LOSS

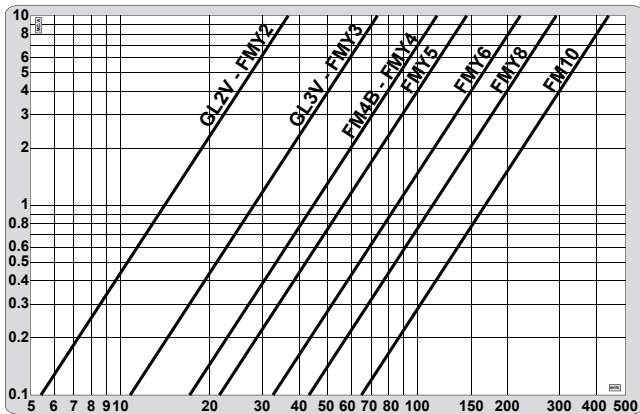

Results obtained in our factory with approved measuring instruments, using clean water as a liquid for assessment and Lama screen of 130 µm.



FM6000

A	B (mm)	C (mm)	D (mm)	E (mm)	Filtration surface (cm <sup>2</sup> )	Net Weight (Kg)	Gross Weight (Kg)	Package volume (m <sup>3</sup> )	Limit Flow (m <sup>2</sup> /h)	Description	Code
2" Thread H	319	165	230	540	1037	11,5	12	0,032	25	2" vertical (external screen)	<b>GL2V</b>
3" Thread H	275	165	230	666	1443	14	15	0,070	50	3" vertical (external screen)	<b>GL3V</b>
2" Thread M	450	165	605	504	1037	12,5	13	0,048	25	2" leaning (external screen)	<b>FMY2</b>
3" Flange	500	165	752	500	1490	20	21	0,089	50	3" leaning (external screen)	<b>FMY3</b>
3" Flange	500	219	500	446	1593	20	22	0,089	50	3" leaning (injected screen)	<b>FM3000</b>
4" Flange	700	219	785	500	2162	30,5	43	0,250	80	4" leaning (external screen)	<b>FM4B</b>
4" Flange	700	250	825	600	2897	36,5	50	0,250	80	4" leaning (external screen)	<b>FMY4</b>
4" Flange	700	219	700	549	2389	37	50	0,250	80	4" leaning (injected screen)	<b>FM4000</b>
5" Flange	700	250	825	600	2897	40,5	65	0,250	100	5" leaning (external screen)	<b>FMY5</b>
6" Flange	730	320	986	923	5038	65	65	0,432	150	6" leaning (external screen)	<b>FMY6</b>
6" Flange	700	219	840	672	3185	65	65	0,432	150	6" leaning (injected screen)	<b>FM6000</b>
8" Flange	900	430	1340	1250	10897	100	153	0,890	200	8" leaning (external screen)	<b>FMY8</b>
10" Flange	1000	430	1525	1430	13112	105	190	1,270	300	10" leaning (external screen)	<b>FM10</b>
4" Flange	649	250	840	310	2897	39	40	0,158	80	4" horizontal (inside screen)	<b>FML4</b>
6" Flange	1420	320	1680	380	8454	Ask	101	0,230	150	6" horizontal (inside screen)	<b>FML6</b>
6" Flange	995	219	1250	350	4778	70	72	0,200	150	4" horizontal (injected screen)	<b>FML6000</b>
8" Flange	1645	320	1930	270	9868	Ask	Ask	Ask	200	8" horizontal (inside screen)	<b>FML8</b>
10" Flange	1623	430	1950	540	15327	Ask	Ask	Ask	300	10" horizontal (inside screen)	<b>F10L</b>
12" Flange	1848	430	2250	590	17541	Ask	Ask	Ask	420	12" horizontal (inside screen)	<b>F12L</b>
16" Flange	1689	600	2143	840	21783	Ask	Ask	Ask	850	16" horizontal (inside screen)	<b>F16L</b>

**Metálicos**

**4.8 Screen Centrifuge. METAL FILTERS**

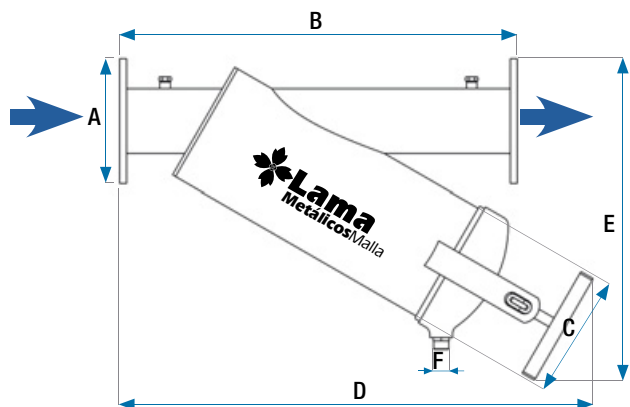

**FC4C**



**FCY6**



A	B (mm)	C (mm)	D (mm)	E (mm)	F	Net Weight (Kg)	Gross Weight (Kg)	Package volume (m <sup>3</sup> )	Limit Flow (m <sup>3</sup> /h)	Filtration Surface (cm <sup>2</sup> )	Description	Code
2" Thread M	450	165	660	560	3/4"	16	18	0,089	22	1.071	2" centrifuge filter	<b>FCY2</b>
3" Flange	500	165	825	570	3/4"	23	26	0,158	37,7	1.590	3" centrifuge filter	<b>FCY3</b>
4" Flange	700	219	840	575	3/4"	33	46	0,250	73,5	2.312	4" centrifuge filter	<b>FC4C</b>
5" Flange	700	250	990	650	3/4"	40	68	0,250	73,5	3.116	5" centrifuge filter	<b>FCY5</b>
6" Flange	730	320	995	900	3/4"	68	88	0,432	148	5.404	6" centrifuge filter	<b>FCY6</b>
											Waste store, valve and programmer	Ask



## 4.8 Screen Semiautomatic. METAL FILTERS

Metálicos

### FILTERING ELEMENT

Thermo soldered stainless steel mesh located in a cylindrical structure of drilled PVC. The standard mesh size is 0,130 mm, but it is available in other sizes (from 0,01 to 3 mm)  
Please ask for prices



FCM6000

FCM4000

FCM3000

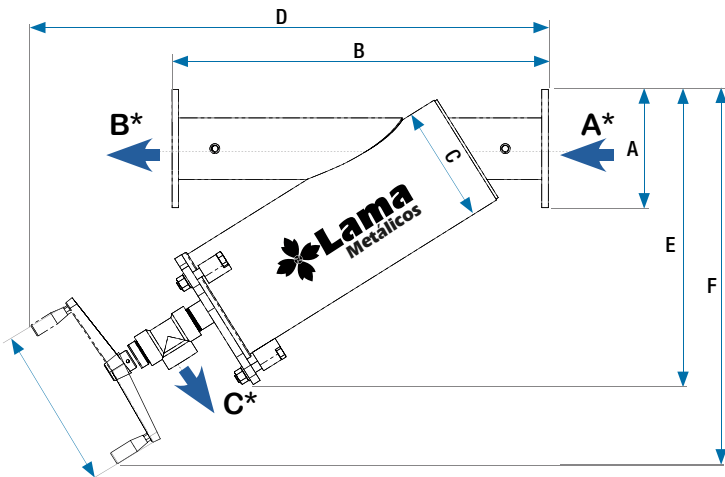

HEAD LOSS

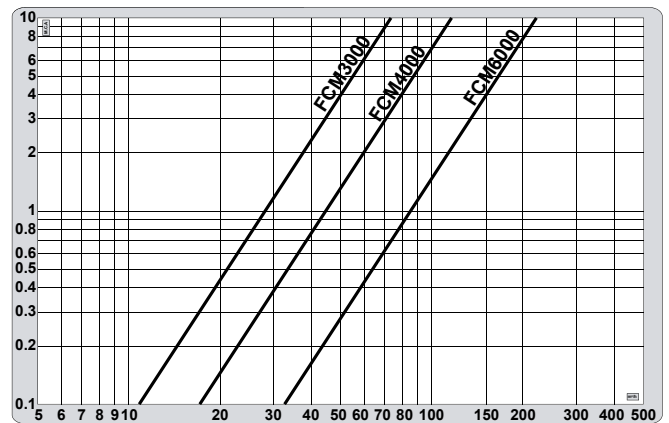

Results obtained in our factory with approved measuring instruments, using clean water as a liquid for assessment and Lama screen of 190 µm.

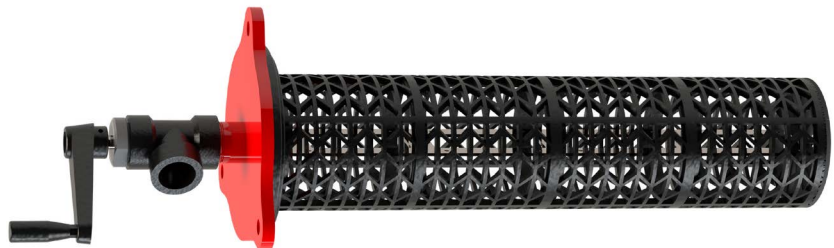

A (mm)	B (mm)	C (mm)	D (mm)	E (mm)	F (mm)	Filtration surface (cm²)	Net Weight (Kg)	Limit flow (m³/h)	Code
3" Flange	500	220	765	450	595	1593	27	45,8	<b>FCM3000</b>
4" Flange	700	220	970	970	700	2389	37	73,5	<b>FCM4000</b>
6" Flange	700	220	1110	675	825	3185	47	159,6	<b>FCM6000</b>

# Programmer



## RIO Programmer

### KIT RIO DESCRIPTION

- RIO Programmer
- Pressure sensors
- Pivot swivel
- Microtube
- Solenoid



Model	
220V AC	12V DC
Code	Code

Filters	1	CE1001SC	CE2001LA
	2	CE1002SC	CE2002LA
	3	CE1003SC	CE2003LA
	4	CE1004SC	CE2004LA
	5	CE1005SC	CE2005LA
	6	CE1006SC	CE2006LA
	7	CE1007SC	CE2007LA
	8	CE1008SC	CE2008LA
	9	CE1009SC	CE2009LA
	10	CE1010SC	CE2010LA
	11	CE1011SC	CE2011LA
	12	CE1012SC	CE2012LA
	13	CE1013SC	CE2013LA
	14	CE1014SC	CE2014LA
	15	CE1015SC	CE2015LA
	16	CE1016SC	CE2016LA

Programmer support	PPCS1M
--------------------	--------



- Ask us for **more stations.**

# Hidrociclón



No standard configuration



Hydrocyclon 3" (HID3)

**HEAD LOSS**

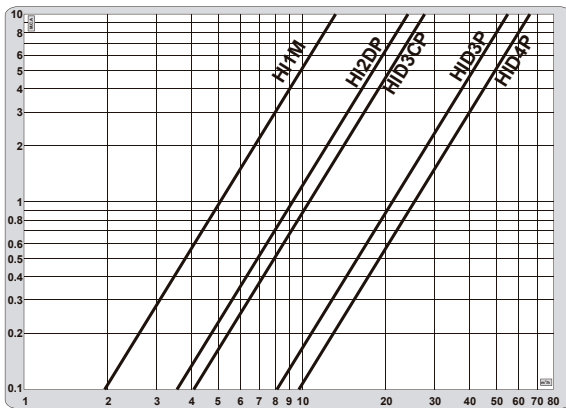

Available  
**PRES MAX 16**  
kg/cm<sup>2</sup>  
228 psi

Available  
**PRES MAX 10**  
kg/cm<sup>2</sup>  
142 psi



A	B (mm)	C (mm)	D (mm)	E (mm)	Net Weight (Kg)	Gross Weight (Kg)	Package volume (m <sup>3</sup> )	Limit Flow (m <sup>3</sup> /h)	Description	Code
1½" Thread M	102	130	462	168	9,20	9,20	0,06	12	1½" Hydrocyclone	<b>HI1M</b>
2" Vic	140	185	1.057	250	21,80	21,80	0,35	22	2" Hydrocyclone Vic	<b>HID2P</b>
2" Thread M	200	245	1.117	250	21,80	21,80	0,35	22	2" Hydrocyclone + Thread	<b>HI2EP</b>
3" Flange	165	210	1.208	300	29,80	49,80	0,56	25	3" Hydrocyclone	<b>HID3CP</b>
3" Flange	200	313	1.600	500	50,60	76,60	1,14	50	3" Hydrocyclone	<b>HID3P</b>
4" Flange	225	302	1.600	500	50,60	76,60	1,14	60	4" Hydrocyclone	<b>HID4P</b>
Automatic cleaning kit 2" 220V (Valve, timer, transformer, solenoid and filter) for one hydrocyclone										<b>KL2C</b>
Automatic cleaning kit 2" batteries (Valve, programmer, solenoid and filter) for one hydrocyclone										<b>KL2MO</b>
Hydrocyclone support 1½"										<b>SH1M</b>

Flow Limit 4m H.D.	Max. recommended flow (m <sup>3</sup> /h)	Description	Code	
			without drainage collector	with drainage collector
32	44	Station made by 2 HID2 Ø4"	<b>HID2PX2</b>	<b>HID2P2D</b>
74	100	Station made by 2 HID3 Ø6"	<b>HID3PX2</b>	<b>HID3P2D</b>
111	150	Station made by 3 HID3 Ø6"	<b>HID3PX3</b>	<b>HID3P3D</b>
148	200	Station made by 4 HID3 Ø8"	<b>HID3PX4</b>	<b>HID3P4D</b>
222	300	Station made by 6 HID3 Ø10"	<b>HID3PX6</b>	<b>HID3P6D</b>
90	120	Station made by 2 HID4 Ø6"	<b>HID4PX2</b>	<b>HID4P2D</b>
135	180	Station made by 3 HID4 Ø8"	<b>HID4PX3</b>	<b>HID4P3D</b>
180	240	Station made by 4 HID4 Ø8"	<b>HID4PX4</b>	<b>HID4P4D</b>
270	360	Station made by 6 HID4 Ø10"	<b>HID4PX6</b>	<b>HID4P6D</b>

# GloboValve



## MATERIALS

- Body:** cast steel
- Membrane:** synthetic rubber nitrile 60 ° Shore
- Shaft:** stainless steel
- Shafts valve:** vulcanized rubber
- Cover:** glass fiber reinforced polyamide

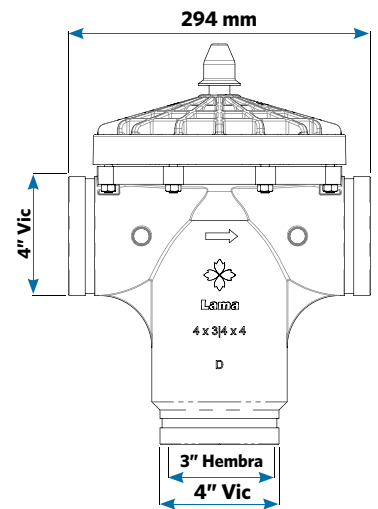
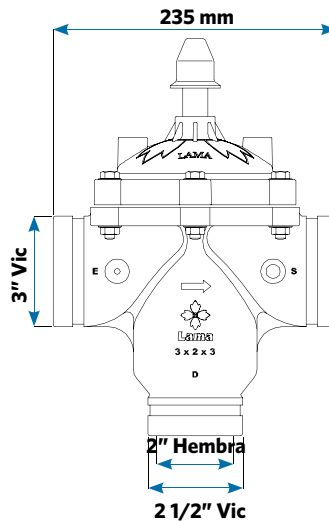
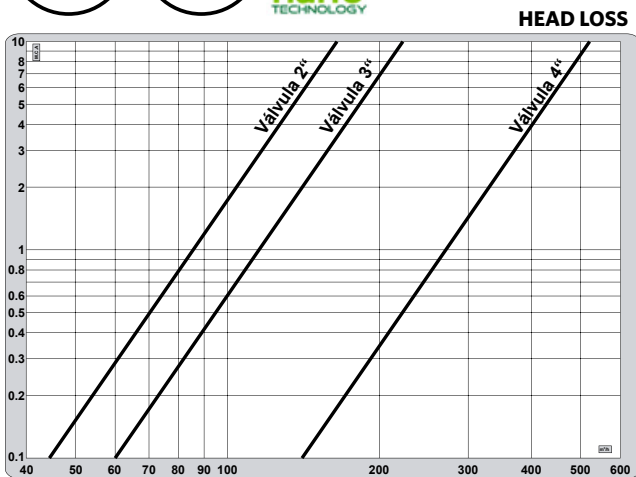

Max. recommended flow (m³/h)		Weight (Kg)	Package volume (m³)	Description	Code
Principal	Drainage				
60	32	8	0,026	3x2x3 Globo basic connection VIC (unequipped)	<b>VN32</b>
150	61	17	0,043	4x3 / 4 x 4 Globo basic connection VIC (unequipped)	<b>VN44</b>
60	32	8	0,026	3x2x3 Globo connection VIC, equipped with solenoid 24V AC N.C.	<b>VC32</b>
150	61	17	0,043	4x3 / 4x4 Globo connection VIC, equipped with solenoid 24V AC N.C.	<b>VC44</b>

# GloboPlastic



## MATERIALS

- Body:** glass fiber reinforced polyamide
- Membrane:** synthetic rubber nitrile 60 ° Shore
- Shaft:** stainless steel
- Shaft valve:** vulcanized rubber
- Cover:** glass fiber reinforced polyamide

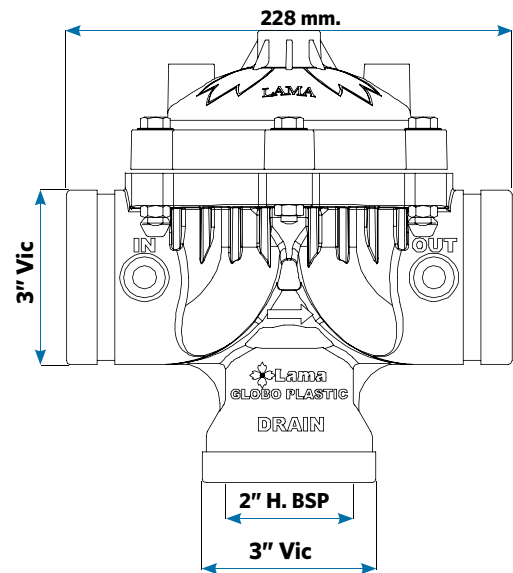
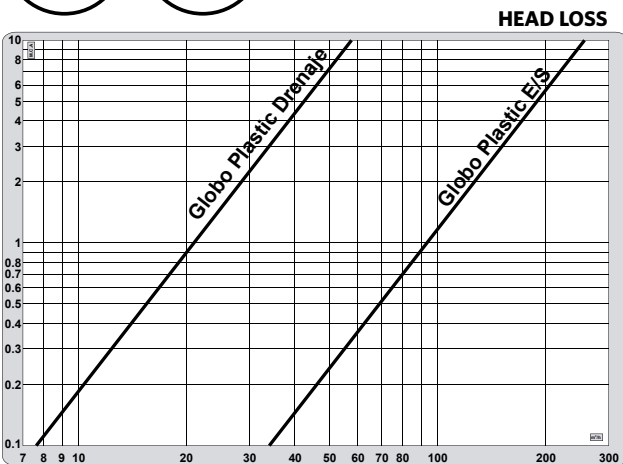

Max. recommended flow (m³/h)		Weight (kg)	Package volume (m³)	Description	Code
Principal	Drainage				
60	32	2	0,026	3x2x3 Globo Plastic connection VIC (unequipped)	<b>VP32</b>
60	32	2,5	0,026	3 x 2 x 3 Globo Plastic connection VIC, equipped with solenoid 24V AC N.C.	<b>VPE3</b>
60	32	3	0,030	3 x 2 x 3 Globo Plastic: 2 connection VIC + 2 flanges (unequipped)	<b>VP32BRI</b>



# Accessoires & spare parts

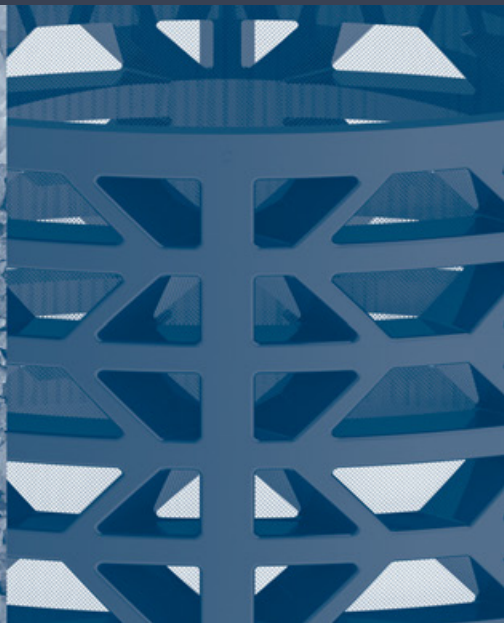
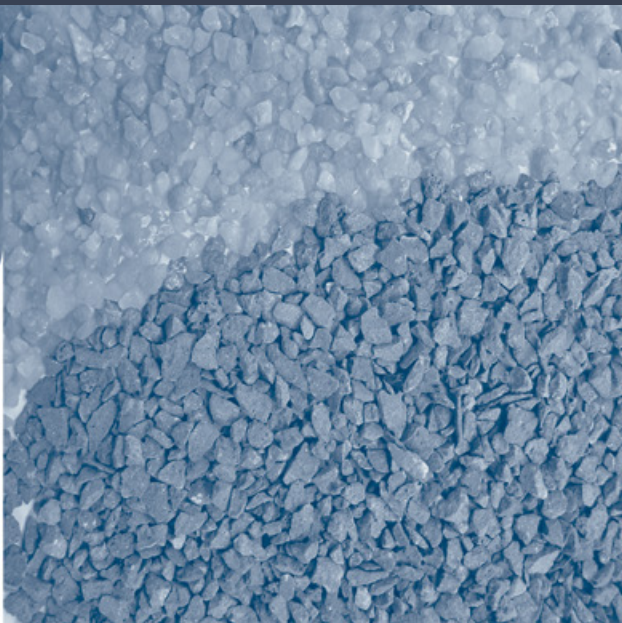



# Accessories

Description	Code
New programmer Mini'S no adjusted for filters EKO, EKOLU and EKOSENIOR (valid for 220V and 12V)	<b>FLMS</b>
New programmer Mini'S no adjusted for filters EKO, EKOLU and EKOSENIOR + PRESSURE GAUGE (valid for 220V and 12V)	<b>FLMSPRE</b>
New programmerr <b>RIO</b>	<b>RIO8P</b>
New programmer <b>RIO 16</b>	<b>RIO16</b>
New touch programmer	-
1/4" LAMA glycerine pressure gauge (Rank of measure from 0 to 10 Kg/cm <sup>2</sup> ) Please ask for others ranks	<b>MANO</b>
Pressure gauge with maximun indicator of 10 Kg/cm <sup>2</sup>	<b>MANA</b>
LAMA differential pressostat (0-1 Kg/cm <sup>2</sup> ) Electric signal	<b>PRES</b>
Pressure sensor for programmers	<b>SPI8</b>
Hydraulic relay (Equipped)	<b>CSLC</b>
Hydraulic relay (Unequipped)	<b>CEBM</b>
Standard solenoid 1/8" 24 VAC N.C.	<b>SLNC</b>
Standard solenoid 1/8" 24 VAC N.A.	<b>SLNA</b>
Latch solenoid 1/8"	<b>LACH</b>
12V Battery equipped with charge controller and waterproof case	<b>BATEEQ</b>
Battery 12V	<b>BATE</b>
Solar collector 12V	<b>PLAC</b>
1" Hydraulic plastic valve	<b>VH1P</b>
1½" Hydraulic plastic valve	<b>VH12P</b>
2" Hydraulic plastic valve	<b>VH2P</b>
2" Hydraulic metallic valve	<b>VHC2</b>
3" Hydraulic metallic valve	<b>VH3C</b>
LAMA`s 2" automatic suction pad, double effect	<b>VE2L</b>
LAMA`s 1" automatic suction pad, double effect	<b>VE1L</b>
LAMA`s 1" sphere suction pad, double effect	<b>VV1L</b>
Option connection flange 3" valve 3×2×3	<b>KCV3</b>
Option Connection flange 4" valve 3×2×3	<b>KCV4</b>
Grooved VIC 2" to thread BSP 2" (Metal)	<b>PON2</b>
Grooved VIC 3" to thread BSP 3" (Metal)	<b>PON3</b>
Grooved VIC 4" to thread BSP 4" (Metal)	<b>PON4</b>



New Programmer **RIO**



Programmer **Mini'S**



Hydraulic relay



Sensor



Solenoid



Suction pad 1"



Suction pad 2"



Grooved Vic

## Accesorios

Description	Code
220V Electrical motor for suction scanner	<b>MOEL220</b>
3" LAMA stabilizing valve completely equipped	<b>VSL3</b>
4" LAMA stabilizing valve completely equipped	<b>VSL4</b>
6" LAMA stabilizing valve completely equipped	<b>VSL6</b>
8" LAMA stabilizing valve completely equipped	<b>VSL8</b>
10" LAMA stabilizing valve completely equipped	<b>VSL1</b>
12" LAMA stabilizing valve completely equipped	<b>VS12</b>
14" LAMA stabilizing valve completely equipped	<b>VS14</b>
3" LAMA stabilizing valve completely equipped for ITS	<b>VSL3INT</b>
4" LAMA stabilizing valve completely equipped for ITS	<b>VSL4INT</b>
6" LAMA stabilizing valve completely equipped for ITS	<b>VSL6INT</b>
8" LAMA stabilizing valve completely equipped for ITS	<b>VSL8INT</b>
10" LAMA stabilizing valve completely equipped for ITS	<b>VS10INT</b>
12" LAMA stabilizing valve completely equipped for ITS	<b>VS12INT</b>
14" LAMA stabilizing valve completely equipped for ITS	<b>VS14INT</b>
Butterfly valve "Sandwich" 3"	<b>VMP3</b>
Butterfly valve "Vic" 3"	<b>VM3V</b>
Butterfly valve "Sandwich" 4"	<b>VMP4</b>
Butterfly valve "Sandwich" 5"	<b>VMP5</b>
Butterfly valve "Sandwich" 6"	<b>VMP6</b>
Butterfly valve "Sandwich" 8"	<b>VMP8</b>
2" VIC conection	<b>VIC2</b>
3" VIC conection	<b>VIC3</b>
4" VIC conection	<b>VIC4</b>
6" VIC conection	<b>VIC6</b>
3" Plastic VIC conection	<b>VIC3PLA</b>
4" Plastic VIC conection	<b>VIC4PLA</b>
3"-2" VIC conection	<b>VIC32</b>
4"-3" VIC conection	<b>VIC43</b>
2" Female thread BSP to 2" VIC grooved (plastic) and joint ring	<b>RHV2</b>
3" Female thread BSP to 3" VIC grooved (Plastic) and joint ring	<b>RHV3</b>
3" DIN 2546 flange to 3" VIC grooved (Metal)	<b>B3EV</b>
4" DIN 2546 flange to 4" VIC grooved (Metal)	<b>B4EV</b>
3" DIN 2546 flange to 3" female thread BSP (Metal)	<b>BR3H</b>
3" Flange other norms to 3" female thread BSP (Metal)	-



Electric motor



Stabilizing valve completely



Butterfly valve









Vic connection



Vic plastic

## Disc spare parts

Filter Code	FILTERING CARTRIDGE		CLOSING JOINTS			
	NEW		UPPER		LOWER	
	Code	Size (mm)	Code	Size (mm)	Code	Size (mm)
<b>FV2D</b>	<b>CA2R</b>	110 x 345	<b>JFMA</b>	175 x 90	<b>JFMB</b>	150 x 85
<b>FV3D</b>	<b>CA3R</b>	110 x 495	<b>JFMA</b>	175 x 90	<b>JFMB</b>	150 x 85
<b>FY2D</b>	<b>CA2R</b>	110 x 345	<b>JFMA</b>	175 x 90	<b>JFMB</b>	150 x 85
<b>FY3D</b>	<b>CA3R</b>	110 x 495	<b>JFMA</b>	175 x 90	<b>JFMB</b>	150 x 85
<b>FD4D</b>	<b>(2)CA3R</b>	110 x 495	<b>(2)JFMA</b>	175 x 90	<b>(2)JFPD</b>	120 x 80
<b>FDS2</b>	<b>CS2R</b>	110 x 345	-	-	<b>T103</b>	98 x 3
<b>FVD3/FDS3</b>	<b>CS3R</b>	110 x 500	-	-	<b>T103</b>	98 x 3
<b>FDC2</b>	<b>CRC2</b>	110 x 325	<b>T103</b>	98 x 3	-	-
<b>FVA3/FDC3</b>	<b>CRC3</b>	110 x 470	<b>T103</b>	98 x 3	-	-

Number of disc in an Autosensor filter	Size	Tower number	 190µ	 130µ	 100µ	 250µ	 50µ	 20µ
<b>FAS3TR</b>	3"	1	337	401	-	335	500	510
<b>FA4P</b>	4"	2	337	401	-	335	500	510

Description	Code
LAMA parallel green disc (disc opening 20 microns)	<b>ANVE</b>
LAMA parallel blue disc (disc opening 50 microns)	<b>ANAZ</b>
LAMA parallel orange disc (disc opening 100 microns)	<b>ANNA</b>
LAMA parallel yellow disc (disc opening 115 microns)	<b>ANAM</b>
LAMA parallel red disc (disc opening 190 microns)	<b>ANIL</b>
LAMA parallel brown disc (disc opening 250 microns)	<b>ANMA</b>



## Sand spare parts

Ø Body (mm.)	CENTRAL COLLECTOR	VOLCANIC SAND CODE ARBA	CLOSING JOINTS			
	Code	Code	UPPER		LOWER	
			Code	Size (mm)	Code	Size (mm)
350 Collectors	<b>TEU1</b>	<b>30 Kg</b>	<b>J175</b>	175 x 145	<b>TML2</b> (blockage)	-
500 Collectors	<b>TE1½</b>	<b>100 Kg</b>	<b>J175</b>	175 x 145	<b>J175</b>	175 x 145
700 Collectors	<b>TEU2</b>	<b>200 Kg</b>	<b>J175</b>	175 x 145	<b>J175</b>	175 x 145
800 Collectors	<b>TE3C</b>	<b>300 Kg</b>	<b>J175</b>	175 x 145	<b>J175</b>	175 x 145
950 Collectors	<b>TEU3</b>	<b>500 Kg</b>	<b>J175</b>	175 x 145	<b>J175</b>	175 x 145
1.200 Collectors	<b>TEU4</b>	<b>800 Kg</b>	<b>J175</b>	175 x 145	<b>J175</b>	175 x 145
700 Mushrooms	<b>(21 units)</b>	<b>170 Kg</b>	<b>J175</b>	175 x 145	<b>J175</b>	175 x 145
950 Mushrooms	<b>(24 units)</b>	<b>420 Kg</b>	<b>J175</b>	175 x 145	<b>J175</b>	175 x 145
1.200 Mushrooms	<b>(24 units)</b>	<b>700 Kg</b>	<b>J175</b>	175 x 145	<b>J175</b>	175 x 145





**Injected screen**

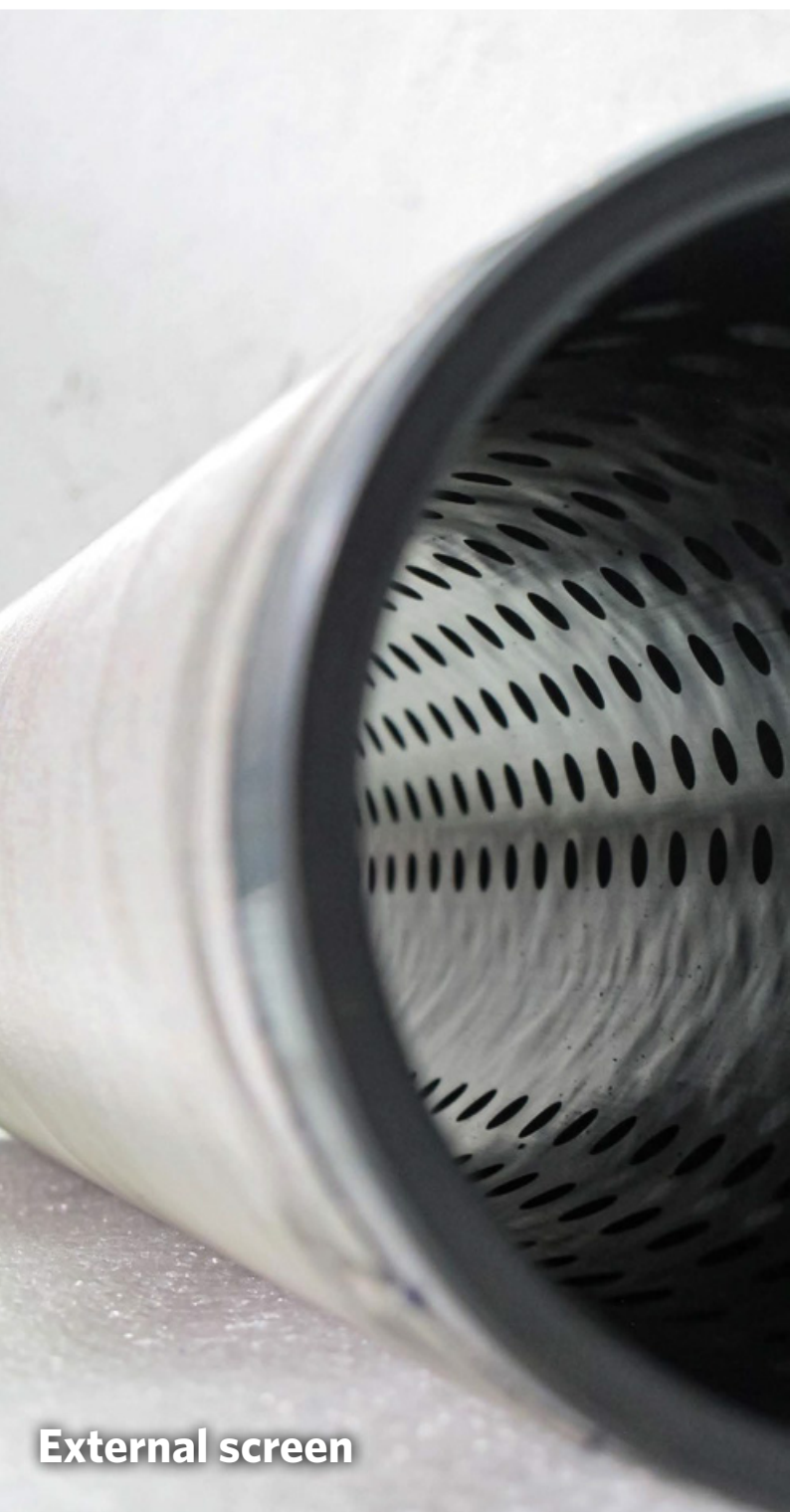

**External screen**

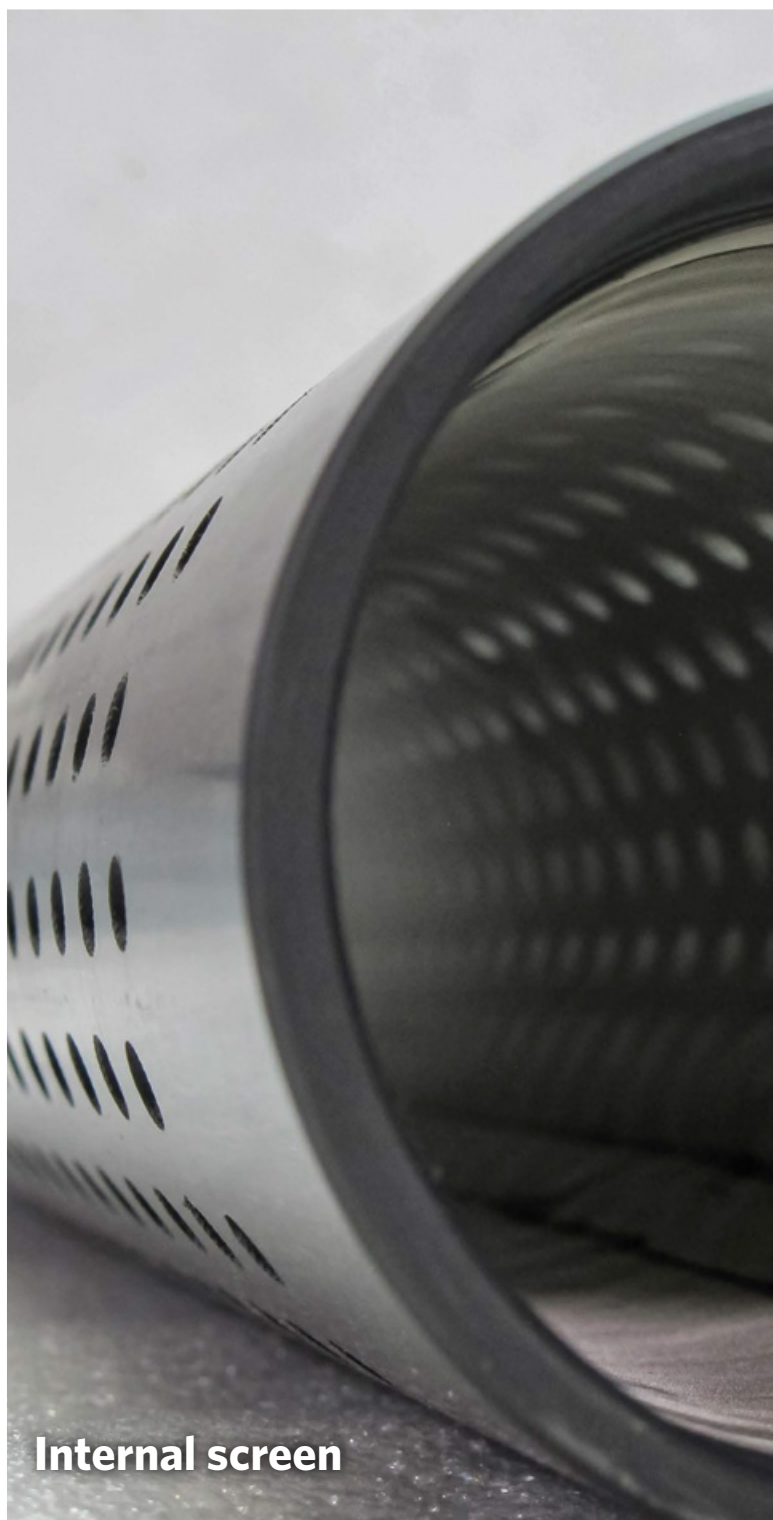

**Internal screen**

## Screen spare parts

Filter Code	FILTERING CARTRIDGE				CLOSING JOINTS		
	NEW		SCREEN REPLACEMENT	COVER JOINT		INSIDE JOINT	
	Code	Size (mm)	Code	Code	Size (mm)	Code	Size (mm)
GL2V	CGL2*	110 x 344	MGL2	JFMA	175 x 90	JFMB	150 x 85
GL3V	CFM3*	110 x 494	MFM3	JFMA	175 x 90	JFMB	150 x 85
FMY2	CGL2*	110 X 344	MGL2	JFMA	175 x 90	JFMB	150 x 85
FMY3	CFM3*	110 x 494	MFM3	JFMA	175 x 90	JFMB	150 x 85
FM4B	CF4B*	160 x 488	MF4B	J4BA	230 x 125	J4BB	205 x 125
FMY4	CFM4	160 x 654	MFM4	JTLA	260 x 130	JTLB	235 x 125
FMY5	CFM5	160 x 654	MFM5	JTLA	260 x 130	JTLB	235 x 125
FMY6	CFM6	200 x 891	MFM6	JF6A	335 x 160	JF6B	215 x 165
FMY8	CFM8	315 x 1230	MFM8	J315/JA35	330 x 275	J315	330 x 275
FM10	CF10	315 x 1480	MF10	J315/JA35	330 x 275	J315	330 x 275
FML4	CFM5	160 x 654	MFM5	JTLA	130 x 260	JTLB	235 x 125
FML6	CFL6	200 x 1495	MFL6	JF6A	160 x 335	JF6B	215 x 165
FML8	CFL8	200 x 1745	MFL8	JF6A	160 x 335	JF6B	215 x 165
F10L	CL10	315 x 1730	ML10	J315/JA35	330 x 275	J315	330 x 275
F12L	CL12	315 x 1980	ML12	J315/JA35	330 x 275	J400	-
F16L	CL16	400 x 1874	ML16	JB24	-	T103	98 x 3
FMS2	CMS2*	110 x 348	MMS2	-	-	T103	98 x 3
FVM3/FMS3	CMS3*	110 x 501	MMS3	-	-	T103	98 x 3
A1MI	CA11/2	160 x 210	MA1½	JCA2	230 x 65	JFA2	210 x 127
A2CI	CAU2	160 x 280	MAU2	JCA2	230 x 65	JFA2	210 x 127
A3CI	CAU3	315 x 280	MAU3	JCA4	420 x 95	J315	330 x 275
A4CI	CAU4	315 x 463	MAU4	JCA4	420 x 95	J315	330 x 275
A5CI	CAU5	315 x 519	MAU5	JCA4	420 x 95	J315	330 x 275
A6CI	CAU6	315 x 668	MAU6	JCA4	420 x 95	J315	330 x 275
A8ETMBI	C8EG200	315 x 1039	MA8ET	JCA4	420 x 95	J315	330 x 275
A10ETBI	C10EG20	315 x 1095	M10C	JCA4	420 x 95	J315	330 x 275
A12ETBI	C12EG20	315 x 1299	M12A	JCA4	420 x 95	J315	330 x 275
FCY2	CFY2	110 x 344	MFY2	JFMA	175 x 90	JC3B	150 x deflector
FCY3	CFY3	110 x 494	MFY3	JFMA	175 x 90	JC3B	150 x deflector
FC4C	CF4C	160 x 488	MF4C	J4BA	230 x 125	J4CB	205 x deflector
FCY5	CFM5	160 x 654	MFM5	JTLA	260 x 130	JC4B	235 x deflector
FCY6	CFY6	200 x 891	MFY6	JF6A	335 x 160	JF6B	215 x 165
FCS2	CCS2	110 x 331	MCS2	T103	98 x 3	JFSA	120 x deflector
FVC3/FCS3	CCS3	110 x 480	MCS3	T103	98 x 3	JFSA	120 x deflector

Codes having an asterisk \* mean that the filtration cartridge has an outside screen.

Cartridge section	Ø 282	135 mm	0,190 mm screen	<b>T28P135</b>
Cartridge section	Ø 144	176 mm	0,190 mm screen	<b>T14P176</b>
Cartridge section	Ø 282	135 mm	0,130 mm screen	<b>T28P13R</b>
Cartridge section	Ø 144	176 mm	0,130 mm screen	<b>T14P17R</b>





## Sales Conditions



### ORDERS

All orders must be made in writing and signed by a duly accredited person, indicating the place of destination and means of transport for the goods. Orders can be anticipated by telephone and must be ratified in writing. The accepted orders will be subject to the terms and conditions of sale of **FERNANDO LAMA S.L.U.** and **LAMA SISTEMAS DE FILTRADO S.L.U.**

Orders must be placed by e-mail to the address:

**lama@lama.es**

If it is a new item, you must indicate the quantity and the code or trade name of it.

- If it is a spare material, in addition to the quantity and the code or trade name of the selected item, you must also indicate the lot number or the purchase invoice of the station for which the spare parts are intended.

- If it is an old equipment, we have the necessary spare parts and you can request them in writing in any of the ways mentioned above.

On our website you can find all descriptions and take apart of the equipment you need **www.lama.es**

Our goods are served under reservation of title until full payment of the debt according to Law 3/2004 of December 29.



### SHIPPING

Unanticipated freight and costs (packaging, sea and air shipments) are under the **responsibility and risk of the buyer**; as well as the import documentation in the countries of destination and the extra documents required by the banks.

The **goods always travel at the risk of the buyer**, and the insurance is at the buyer's expense. The company considers the goods to be ready for dispatch correctly packed and placed on the truck, at the factory. Please check the goods received. In the event of any incident, please leave a written record on the agency's delivery note. Any damage produced during transport must be claimed to the agency offering the service within a maximum period of 24 hours from receipt of the goods.

**LAMA sells EX-WORKS.**



### RETURN

**No returns or claims will be accepted after 15 days of receipt.**

Returns will be charged with **10% of the invoiced amount for packaging costs** and must come with their original packaging in perfect condition.

The use of the products for aims and pressures different from the recommended ones, will exempt to **FERNANDO LAMA, S.L.U.** and **LAMA SISTEMAS DE FILTRADO, S.L.U.**, of any responsibility.

## Payment



### CASH

Those orders paid to **LAMA SISTEMAS DE FILTRADO S.L.U.** or **FERNANDO LAMA S.L.U.**, before the expedition of the material, are considered cash sales.



### DEFERRED PAYMENT

Applicable only to distributors who have met the company's business requirements. Payment will be made, at the latest, **60 days after the invoice date** (Law 15/2010 of July 5th), direct debited, accepted by bank transfer and guaranteed by the insurance company.

The method of payment by confirming will lead to an increase in financial expenses of **2.5%**.

The **first order** (new customer) **will be made in cash.**

The materials remain the property of the manufacturer until **full payment is made.**

Orders will be accepted and invoiced at the prices in force on the **date of dispatch.**

**FERNANDO LAMA S.L.U.** or **LAMA SISTEMAS DE FILTRADO S.L.U.** can **change the prices without notifying the customer.**

The expressed prices in the price list do not include taxes.

In the event of non-payment, **interest on arrears** and other costs incurred **shall be borne by the purchaser.**

The invoice will be in **euros (€).**



**IMPORTANT WARNING:** the price tariff for the current fiscal year 2023, that is published herein, is merely informative, and is an estimation, so it could undergo changes throughout the year due to possible changes in the price of raw materials. The company is neither subject to nor obliged to maintain the prices indicated in the tariff, nor to publish any potential variation thereof. The version of the website <https://lama.es/distribuidores-lama> is the current and updated version.



[www.lama.es](http://www.lama.es)

---

#### **SPAIN**

Calle Artesanía 1-3-5, Polígono Industrial Guadalquivir, 41120 Gelves (Sevilla) Spain - Telf. (+34) 955 77 77 10 - [lama@lama.es](mailto:lama@lama.es)

---

#### **MAROC**

Lot. Banque Populaire, 73 Rue Arrahma N° 8 Porte Droite B - Tanger, Maroc  
[maroc@lama.es](mailto:maroc@lama.es)

Portab.: 00212 (0) 6 61 42 36 05 - Telf.: 00212 (0) 5 39 31 32 12 - Fax: 00212 (0) 5 39 31 32 11

---

**TUNISIE** - Bureau Commercial: [tunisie@lama.es](mailto:tunisie@lama.es)

---

**FRANCE** - Bureau Commercial: [france@lama.es](mailto:france@lama.es)

---

**CHILE** - Oficina Comercial: [chile@lama.es](mailto:chile@lama.es)

---

**MÉXICO** - Oficina Comercial: [mexico@lama.es](mailto:mexico@lama.es)

---

**PERÚ** - Oficina Comercial: [peru@lama.es](mailto:peru@lama.es)

---

**PORTUGAL** - Commercial Office: [portugal@lama.es](mailto:portugal@lama.es)

---

**IRAN** - Commercial Office: [iran@lama.es](mailto:iran@lama.es)